

DCS & Labeling Worldwide

GT408/412/424e Printer



OPERATOR MANUAL

SATO America, Inc.

10350A Nations Ford Road
Charlotte, NC 28273

Main Phone: (704) 644.1650

Technical Support Hotline: (704) 644.1660

Technical Support Fax: (707) 644.1661

E-Mail: satosales@satoamerica.com

technical.support@satoamerica.com

www.satoamerica.com

WARNING

THE EQUIPMENT REFERENCED IN THIS DOCUMENT COMPLIES WITH THE REQUIREMENTS IN PART 15 OF FCC RULES FOR A CLASS B COMPUTING DEVICE. OPERATION OF THIS EQUIPMENT IN A RESIDENTIAL AREA MAY CAUSE UNACCEPTABLE INTERFERENCE TO RADIO AND TV RECEPTION.

TABLE OF CONTENTS

INTRODUCTION

About This Manual	1-2
General Description	1-3
Control Features	1-4

TECHNICAL DATA

Physical Characteristics	2-2
Power	2-2
Environmental	2-2
Processing	2-2
Command	2-2
Interface Modules	2-2
Print	2-3
Media	2-3
Ribbon	2-3
Sensing	2-3
Character Font Capabilities	2-4
Barcode Capabilities	2-5
Regulatory	2-5

INSTALLATION

Unpacking & Parts Identification	3-2
Printer Installation	3-2
Site Location	3-3
Cable Connection	3-3
Media Selection	3-4
Media & Ribbon Loading	3-4
Interface Selection	3-6
RS232C Serial Interface	3-6
IEEE1284 Parallel Interface	3-8
Universal Serial BUS (USB) Adapter	3-9
Local Area Network (LAN) Ethernet	3-9
802.11B Wireless	3-9
Receive Buffer	3-10
ACK/NAK Protocol	3-10
Accessories Installation	3-11
External Signal Connector	3-11
Memory Expansion	3-12
Interface Upgrade	3-13
Label Cutter	3-14
Label Peeler	3-14

PRINTER CONFIGURATION

Configuration Modes	4-2
Normal Mode	4-2
User Mode	4-3
Advanced Mode	4-4
IEEE1284 Interface Setup Mode	4-5
RS232C Interface Setup Mode	4-6
Centronics Interface Setup Mode	4-7
LAN Interface Setup Mode	4-8
USB Interface Setup Mode	4-9
Cartridge Mode	4-10
SEMBL Mode	4-11
Test Print Mode	4-12
Download Mode	4-13
Hex Dump Mode	4-14
Boot Download Mode	4-15
Data Save Mode	4-16
Default Settings Mode	4-17
Print Cancel Mode	4-18
Print Darkness Default Mode	4-19
Service Mode	4-20
Factory Mode	4-21
Screen Identification	4-22

TROUBLESHOOTING

Error Signals	5-2
Troubleshooting Table	5-7
Interface Troubleshooting	5-9
Parallel Interface	5-9
RS232 Serial Interface	5-9
LAN Ethernet Interface	5-10
Universal Serial Bus (USB) Interface	5-10
Test Print Troubleshooting	5-11
Hex Dump Mode	5-11
Test Label Printing	5-12
Sensor Locations	5-14

MAINTENANCE

Cleaning Procedures	6-2
Replacement Procedures	6-3
Print Head	6-3
Platen Roller	6-4
Adjustment Procedures	6-6
Print Head Alignment	6-6
Print Head Pressure	6-7
Print Head Balance	6-8
Ribbon Guide	6-9
Label Sensor Positioning	6-10
Potentiometer Adjustments	6-11

1

INTRODUCTION

- **About This Manual**
- **General Description**
- **Control Features**

ABOUT THIS MANUAL

This manual is laid out consistent with the product discussed and provides all of the information required for printer maintenance and repair by SATO approved personnel. For the repair technician, this manual is intended to compliment, and to be used as an extension of, owner/operator literature.

This manual also incorporates the use of special information boxes. Examples of these boxes and the type of information provided in each, are below.

WARNING: PROVIDES INFORMATION THAT, IF UNHEEDED, MAY RESULT IN PRESONAL INJURY.

CAUTION: PROVIDES INFORMATION THAT, IF UNHEEDED, MAY RESULT IN EQUIPMENT DAMAGE.

NOTE: Provides helpful hints to assist in performing the tasks at hand.

LCD DISPLAY: Provides the specific display that should be visible on the LCD at that point.

A comprehensive Table Of Contents provided at the front of this manual facilitates rapid movement within. The contents identify the different Units, Chapters, and Sections. Each references the page number of their commencement.

The pages of this manual have embedded headers and footers to assist the user in identifying his or her exact position within the manual. The header provides the section number followed by its name. The footer identifies the product on the left, the manual's part number in the center, and the page number to the right side of the page.

Page enumeration is two-part with each separated by a hyphen. The first character set references the Unit and the second identifies the page number. Page numbers begin with the numeral (1) one at the commencement of a new unit and ascends sequentially.

GENERAL DESCRIPTION

The GT4xxe series printer is a high-performance printer capable of printing all popular bar codes and twelve human-readable fonts; providing an inventory of thousands of styles and sizes. Its heavy metal construction is designed to deliver optimum performance in demanding environments.

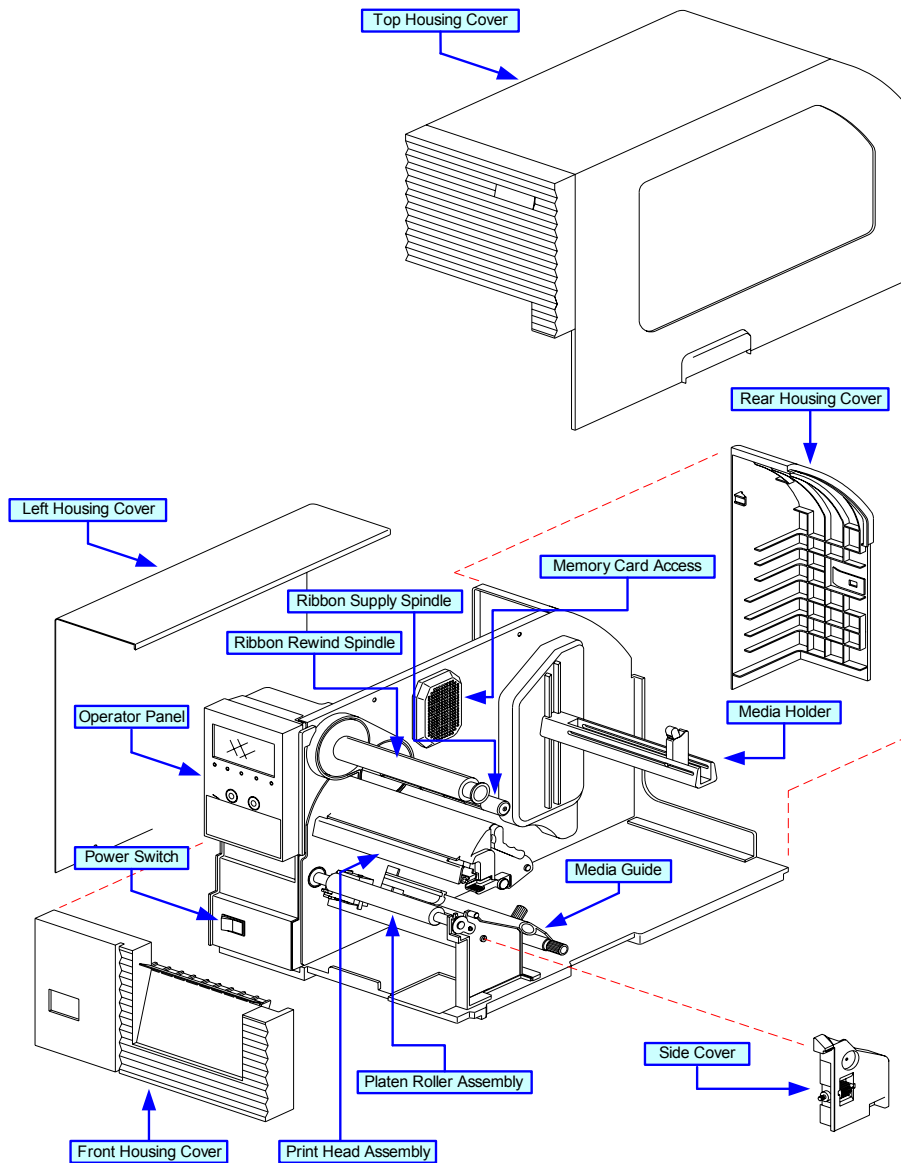

Figure 1-1a, Primary Components

CONTROL FEATURES

This chapter identifies the interactive control features of the printer. These functions are generally defined here. More specific explanations will be found throughout this manual on how to use them.

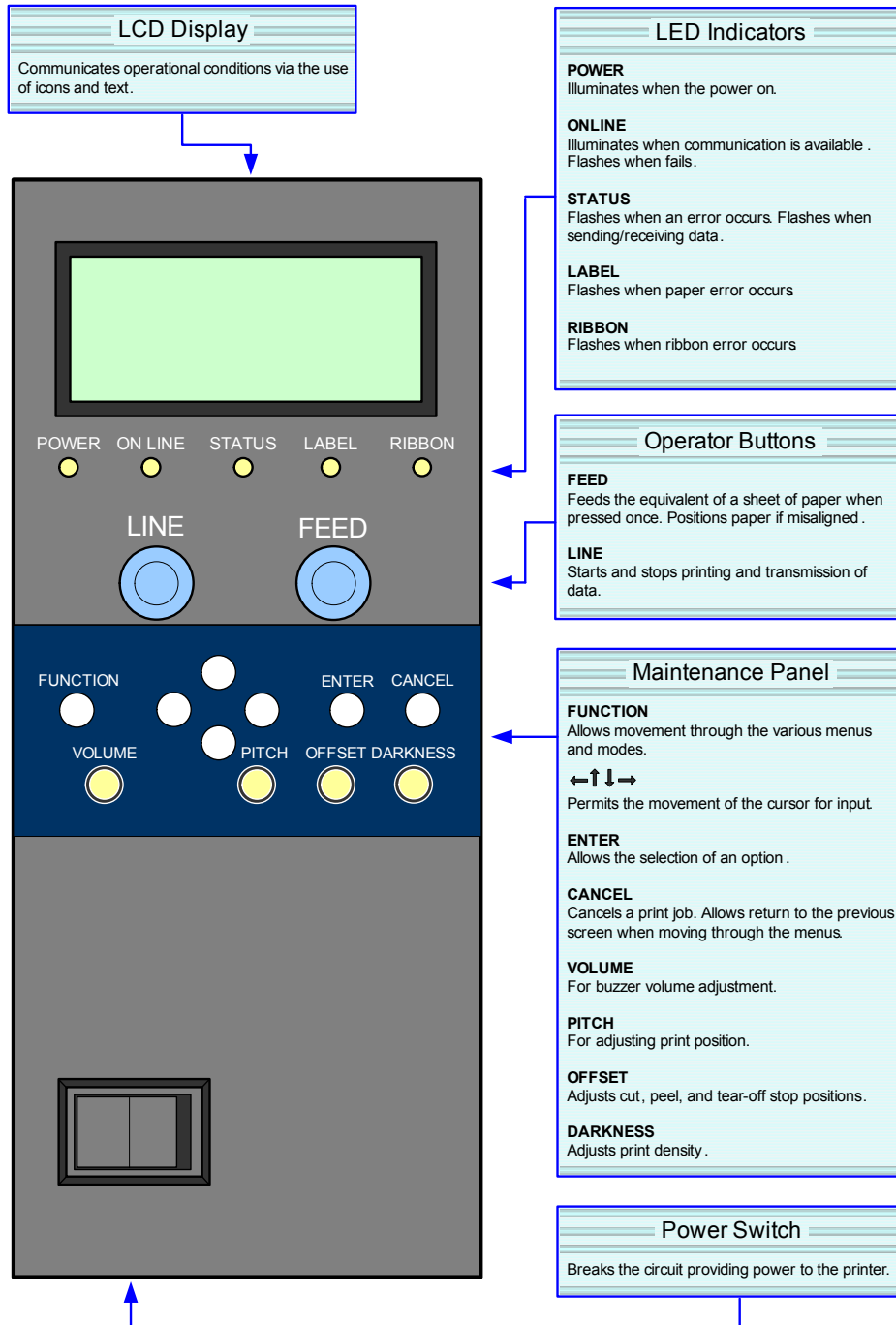

Figure 1-2, Operator Panel

2

TECHNICAL DATA

- **Physical Characteristics**
- **Power**
- **Environmental**
- **Processing**
- **Print**
- **Media**
- **Ribbon**
- **Sensing**
- **Interface Modules**
- **Character Font Capabilities**
- **Barcode Capabilities**
- **Regulatory Approvals**

PHYSICAL CHARACTERISTICS	
Width	10.67 Inches (271 mm)
Height	12.00 Inches (305 mm)
Depth	17.90 Inches (455 mm)
Weight	33.07 Pounds (15.0 Kg) standard

POWER	
Input Voltage	100-240 Volts AC +/- 10%, 50/60 Hertz +/-5%
Power Consumption	200 Volts/150 Watts Operating, 89 Volts/40 Watts Idle

ENVIRONMENTAL	
Operating Temperature	32° to 104°F (0° to 40°C)
Storage Temperature	23° to 140°F (-5° to 60°C)
Storage Humidity	30 to 90% RH Non-Condensing
Operating Humidity	30 to 80% RH Non-Condensing

PROCESSING	
CPU	32 Bit RISC
Flash ROM	2 Megabytes
SDRAM	4 Megabytes
Receive Buffer	2.95 Megabytes
Extended Memory	Flash Memory Board (8 Megabytes)

COMMAND	
Standard	SATO Barcode Printer Language (SBPL) Intelligent Command
Optional	SATO Embedded Basic Language (SEMBL)

INTERFACE MODULES	
Enhanced Parallel Port	IEEE1284 (ECP Compatible)
Centronics Parallel Port	Centronics
Serial Port	RS232C (9600 to 57,600 bps) Standard RS422/485 (9600 to 57600 bps) Optional
Universal Serial Bus	USB Adapter (12 Mbps)
LAN	10BASE-T/100BASE-TX Automatic Switching
Ethernet (Wireless LAN)	10/100 Base T, 802.11B Wireless Wi-Fi
Mini LAN	10BASE-T/100BASE-TX Automatic Switching

PRINT	
Method	Direct Thermal / Thermal Transfer
Speed (user selectable)	Thermal Transfer: 2, 3, 4, 5, 6, 7, 8, 9, 10, 11, 12 Inches Per Second Direct Thermal: 2, 3, 4, 5, 6 Inches Per Second
Print Module (dot size)	.0049 Inches (.125 mm)
Resolution	203 Dots Per Inch (8 dpmm) 305 Dots Per Inch (12 dpmm) 609 Dots Per Inch (24 dpmm)
Maximum Print Width	4.10 Inches (104 mm)
Maximum Print Length	GT408 Printer: 98.43 Inches (2500 mm) GT412 Printer: 59.06 Inches (1500 mm) GT424 Printer: 15.75 Inches (400 mm)

MEDIA	
Roll Media	Roll Paper: 10.43 Inch (265 mm) maximum diameter. Core Size: 1.5, 3, 4 Inch (38.1, 76.2, 101.6 mm) internal diameter. Wound: Face In / Face Out. Face Out is for linerless only.
Fan-Fold Media	Maximum folded height: 7.87 Inches (200 mm)
Standard Mode	Media Width: 0.87 to 5.04 Inches (22-128 mm) Media Length: 0.24 to 5.04 Inches (6-397 mm)
	Backing Paper Width: 0.98 to 5.16 Inches (25-131 mm) Backing Paper Length: 0.35 to 15.75 Inches (9-400 mm)
Tear-Off	Media Width: 0.87 to 5.04 Inches (22-128 mm) Media Pitch: 0.67 to 5.04 Inches (17-397 mm)
	Backing Paper Width: 0.98 to 5.16 Inches (25-131 mm) Backing Paper Length: 0.79 to 15.75 Inches (20-400 mm)
Thickness	0.002 to 0.010 Inches (0.06 - 0.268 mm)

RIBBON	
Width	Minimum: 1.56 Inches (39.5 mm)
	Maximum: 1.77, 2.32, 2.99, 3.31, 3.62, 4.02, 4.37, 5.04 (45, 59, 76, 84, 92, 102, 111, 128 mm)
Length	492 yards (450 m) roll.
Wound	Face In / Face Out.
Roll Diameter	3.34 Inches (85 mm)

SENSING	
Gap	Adjustable
Reflective Eye-Mark	Adjustable
Label	Adjustable
Continuous Form	Sensor not used.

CHARACTER FONT CAPABILITIES	
MATRIX FONTS	
U	5 dots W x 9 dots H
S	8 dots W x 15 dots H
M	13 dots W x 20 dots H
XU	5 dots W x 9 dots H (Helvetica)
XS	17 dots W x 17 dots H (Univers Condensed Bold)
XM	24 dots W x 24 dots H (Univers Condensed Bold)
OA Font (OCR-A)	
OB Font (OCR-B)	
AUTO SMOOTHING FONTS	
WB	18 dots W x 30 dots H
WL	28 dots W x 52 dots H
XB	48 dots W x 48 dots H (Univers Condensed Bold)
XL	48 dots W x 48 dots H (Sans Serif)
VECTOR FONT	
	Proportional or Fixed Spacing Font Size 50 x 50 dots to 999 x 999 dots Helvetica, 10 Font Variations
AGFA RASTER FONTS	
A Font	CG Times, 8 to 72 pt.
B Font	CG Triumvirate, 8 to 72 pt.
DOWNLOADABLE FONTS	
	Bit Mapped True Type Fonts with Utility Program
CHARACTER CONTROL	
	Expansion up to 12 x in either the X or Y coordinates. Character Pitch Control Line Space Control Journal Print facility 0, 90, 180, and 270 Degree Rotation

BAR CODE CAPABILITIES	
Linear Bar Codes	UPC-A/E CODABAR Code 39 Code 93 Code 128 Interleaved 2 of 5 Matrix 2 of 5 Bookland RSS-14 MSI POSTNET UCC/EAN 128 Customer Barcode
Two Dimensional	QR Code Data Matrix Macro BDF Maxi Code PDF417 Micro PDF417 Truncated PDF QR Code NW-7 (Codabar) Composite Symbology
Ratios	1:2, 1:3, 2:5, User definable bar widths
Bar Height	4 to 999 dots, User programmable
Rotation	0, 90, 180, and 270 Degrees
Sequential Numbering	Sequential numbering of both numerics and bar codes
Custom Characters	RAM storage for special characters
Expansion Ratio of Character	Height: 1-12 times, Width: 1-12 times
Graphics	Full dot addressable graphics, SATO Hex/Binary, BMP or PCX formats
Form Overlay	Form overlay for high-speed editing of complex formats

REGULATORY	
Safety	EN 55022 (Class B), UL (CUL), TUV
Radiant Noise	VCCI (Class B)
AC Line Noise	Over 1000V p-p
Static Electricity	IEC (Level 3)

3

INSTALLATION

- **Unpacking**
- **Parts Identification**
- **Printer Installation**
- **Interface Selection**
- **Accessories Installation**

UNPACKING & PARTS IDENTIFICATION

Unpack the printer as directed in the following procedure.

- 1 Place the shipping container (box) upright on a solid, flat surface.
- 2 Open the box, remove any loose items and the first layer of packing material.
- 3 Carefully lift the printer and accessories from the box and place them on a solid flat surface.
- 4 Remove the plastic covers from the packed items and visually inspect for physical damage.
- 5 Ensure all components are present as dictated on the Packing List.
- 6 Report damaged property.

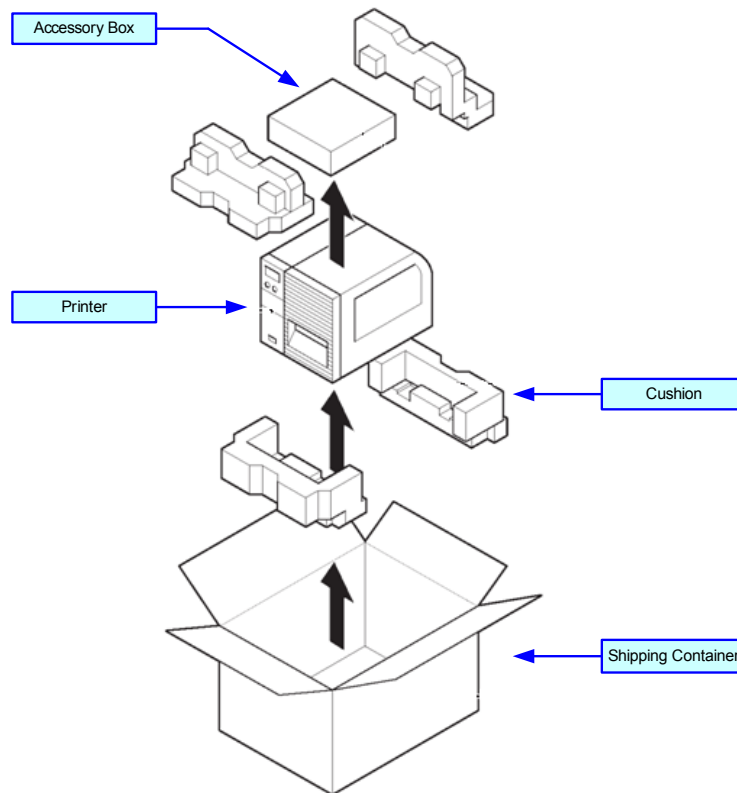

Figure 3-1, Unpacking

PRINTER INSTALLATION

This chapter provides guidance on how to station, connect, and load the printer once unpacked. Following printer setup, proceed to the next chapter for information on interface selection.

SITE LOCATION

- Stationed on a solid flat surface.
- Stationed away from hazardous materials.
- Stationed within operational distance of the host based on interface specifications.

CABLE CONNECTION

The procedure below provides instruction on typical cable connection. The same procedure will apply to others that are not mentioned, but their connectors are also located behind the rear housing cover.

- 1 Press the rear housing cover catch and remove laterally (Figure 3-2a).
- 2 Locate and identify the required connectors (Figure 3-2b).
- 3 Connect the power supply and interface cables to their respective connectors (Figure 3-2c).
- 4 Replace rear housing cover (Figure 3-2d).

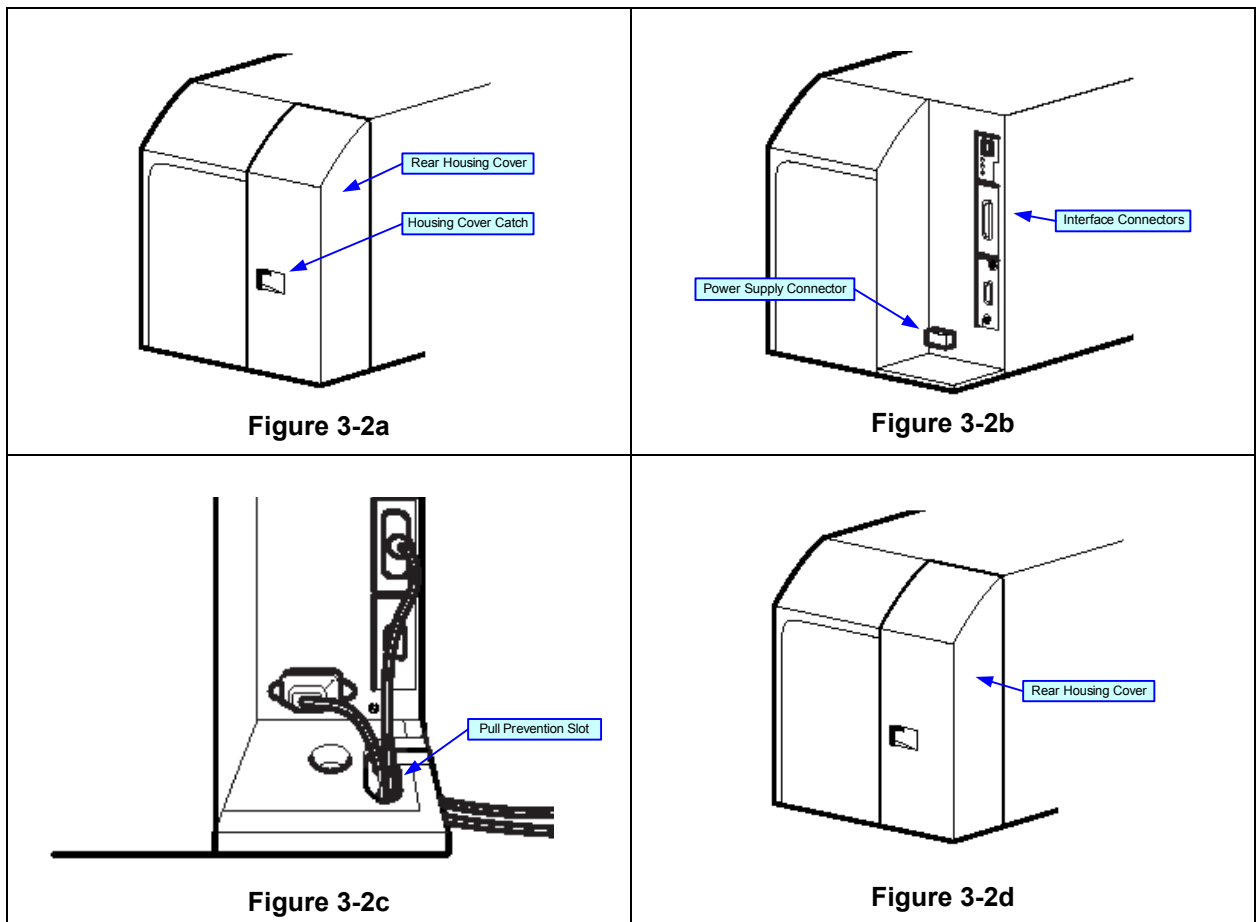

MEDIA SELECTION

The size and type of the labels or tags to be printed should have been taken into consideration before printer purchase. Ideally, the media width will be equal to, or just narrower than, the print head. Using media that does not cover the print head will allow the platen roller to tread on it and wear it out. The media edge will also wear a groove in the platen roller affecting print quality.

MEDIA & RIBBON LOADING

There are two general media types that may be loaded and used; rolled and fan-folded. Each of those types may again be defined by whether their print application is direct thermal or thermal transfer. Those factors determine how the media is loaded and if ribbon stock is loaded at all.

Thermal transfer media requires the use of ribbon stock for print application. In such a scenario, it is the ribbon stock (carbon paper) that contains the ink that will be transferred to the media.

Direct thermal media has the ink embedded within and is brought to the surface through heat penetration by print head contact.

Rolled media of standard diameter is loaded within the printer and suspended by the media holder. Larger, non-standard rolled media would be suspended outside the printer at its rear and fed inward. Fan-folded media would also be fed inward from the rear but is stacked as opposed to suspended.

Refer to Figures 3-3a and 3-3b for proper media routing relative to the type to be used. If that to be used is direct thermal, ignore the ribbon stock in the figures and do not load that.

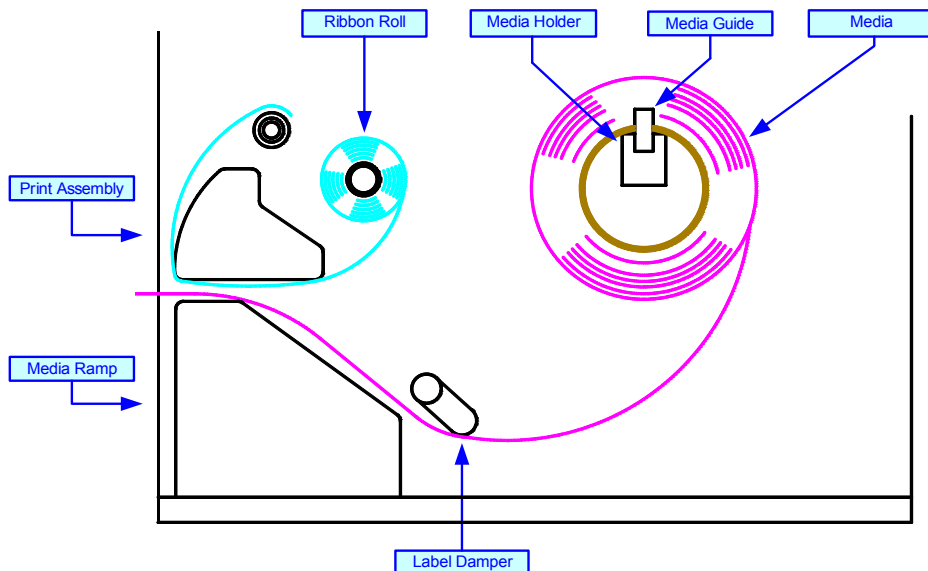

Figure 3-3a, Rolled Media & Ribbon Loading

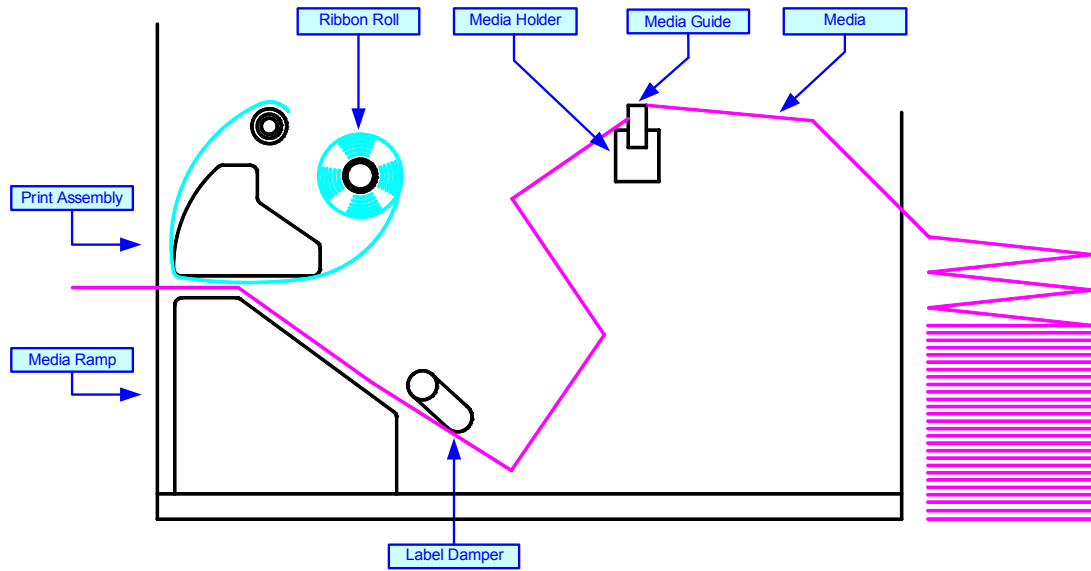

Figure 3-3b, Fan-fold Media & Ribbon Loading

INTERFACE SELECTION

This chapter presents the printer interface types and their specifications. These specifications include detailed information to assist in the selection of the most appropriate method for the printer to interface with the host. The four acceptable interface methods are:

- RS232C Asynchronous Serial
- IEEE1284 Parallel
- Universal Serial Bus (USB) Adapter
- Local Area network (LAN) Ethernet
- 802.11B Wireless

Following the selection of the desired interface, proceed to the following unit for instructions on how to Configure the printer for that interface type.

WARNING: NEVER CONNECT OR DISCONNECT INTERFACE CABLES (OR USE A SWITCH BOX) WITH POWER APPLIED TO EITHER THE HOST OR THE PRINTER. THIS MAY CAUSE DAMAGE TO THE INTERFACE CIRCUITRY IN THE PRINTER/HOST AND IS NOT COVERED BY WARRANTY.

NOTE: Some hosts monitor the Request-To-Send (RTS) signal (pin 4 of 25) to determine if the printer is ready to receive data. Since the printer does not generate this signal, the RTS line must be held true (high) in order to allow communication. This can be performed by connecting the RTS pin to the Clear-To-Send (CTS) signal (pin 5 of 25).

RS232C SERIAL INTERFACE

This High Speed Serial Interface is a Plug-In Interface Module that can be installed in the printer by the user. The only difference between this interface and the TTL is their signal levels and cable pinouts.

RS232C SPECIFICATIONS	
Asynchronous ASCII	Half-duplex communication Bi-Directional Communication
Data Transmission Rate	9600, 19200, 38400, 57600 bps
Data Length	8 bit (selectable)
Stop Bit	1 bit (fixed)
Parity Bit	ODD, EVEN, NONE (selectable)
Codes Used	ASC II Character Codes, JIS Kanji Codes
Control Codes	STX (02H), ETX (03H), ACK (06H), NAK (15H)
Connector	Special
Cable	Special
Signal Levels	High = +5V to +12V, Low = -5V to -12V

RS232C SERIAL INTERFACE SIGNALS		
PIN	DIRECTION	SIGNAL DEFINITION
1	Reference	FG (Frame Ground)
2	To Host	TD (Transmit Data) - Data from the printer to the host computer. Sends X-On/X-Off characters or status data (bi-directional protocols).
3	To Printer	RD (Receive Data) - Data to the printer from the host computer.
4	To Host	RTS (Request to Send) - Used with Ready/Busy flow control to indicate an error condition. RTS is high and remains high unless the print head is open (in this case, RTS would return to the high state after the print head is closed and the printer is placed back on-line) or an error condition occurs during printing (e.g., ribbon out, label out).
5	To Printer	CTS (Clear to Send) - When this line is high, the printer assumes that data is ready to be transmitted. The printer will not receive data when this line is low. If this line is not being used, it should be tied high (to pin 4).
6	To Printer	DSR (Data Set Ready) - When this line is high, the printer will be ready to receive data. This line must be high before data is transmitted. If this line is not being used, it should be tied high (to pin 20).
7	Reference	SG (Signal Ground)
20	To Host	DTR (Data Terminally Ready) - This signal applies to Ready/Busy flow control. The printer is ready to receive data when this pin is high. It goes low when the printer is off-line, either manually or due to an error condition, and while printing in the single job buffer mode. It will also go low when the data in the buffer reaches the buffer near full level.

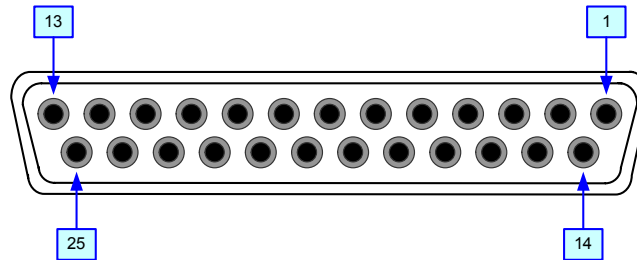

Figure 3-4, Serial Interface Pin Assignments

CABLE REQUIREMENTS					
DB9	DB25	HOST	CONNECTION	DB9	PRINTER
1	1	FG (Frame Ground)	Bi-Directional	1	FG (Frame Ground)
2	3	RD (Receive Data)	To Host	2	TD (Transmit Data)
3	2	TD Transmit Data)	To Printer	3	RD (Receive Data)
8	5	CTS (Clear To Send)	To Printer DB9-6	4	RTS (Request to Send)
4	20	DTR (Data Terminal Ready)	To Printer DB9-4	6	DSR (Data Set Ready)
6	6	DSR* (Data Set Ready)	To Host	9	DTR (Data Terminal Ready)
5	7	SG (Signal Ground)	Bi-Directional	7	SG (Signal Ground)

* This connection at the host side of the interface would depend upon the pin that is being used as the Ready/Busy signal by the driving software. Typically, on a PC, it would be either CTS (pin5) or DSR (pin 6) on a DB-25 connector.

IEEE1284 PARALLEL INTERFACE

The parallel interface is a plug-in module that can be installed by the user and conforms to IEEE1284 specifications. It automatically detects the IEEE1284 signals and operates in the high speed mode. If the IEEE1284 signals are not detected, it will operate in the slower standard Centronics mode. For this reason, an interface cable and host interface conforming to the IEEE1284 specification must be present to fully utilize the speed capabilities. This interface also operates bi-directionally and can report the status of the printer back to the host.

SPECIFICATIONS	
Printer Connector	AMP 57-40360 DDK (or equivalent)
Cable Connector	AMP 57-30360 DDK (or equivalent)
Cable	IEEE1284 Parallel, 10 ft. (3 m) or less
Signal Level	High = +2.4V to +5.0V, Low = 0V to -0.4V
Data Stream	<ESC>A . . Job#1 . . <ESC>Z<ESC>A . . Job#n . . <ESC>Z

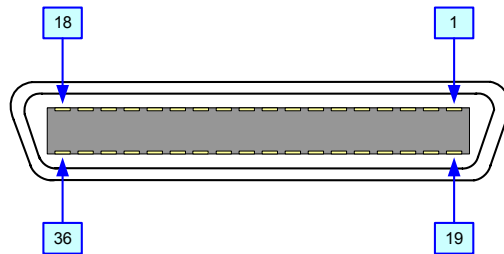

Figure 3-5, Parallel Interface Pin Assignments

IEEE 1284 PARALLEL INTERFACE PIN ASSIGNMENTS					
PIN	SIGNAL	DIRECTION	PIN	SIGNAL	DIRECTION
1	Strobe	To Printer	19	Strobe Return	Reference
2	Data 1	To Printer	20	Data 1 Return	Reference
3	Data 2	To Printer	21	Data 2 Return	Reference
4	Data 3	To Printer	22	Data 3 Return	Reference
5	Data 4	To Printer	23	Data 4 Return	Reference
6	Data 5	To Printer	24	Data 5 Return	Reference
7	Data 6	To Printer	25	Data 6 Return	Reference
8	Data 7	To Printer	26	Data 7 Return	Reference
9	Data 8	To Printer	27	Data 8 Return	Reference
10	ACK	To Host	28	ACK Return	Reference
11	Busy	To Host	29	Busy Return	Reference
12	Ptr Error	To Host	30	PE Return	Reference
13	Select	To Host	31	INIT	From Host
14	AutoFD ₁	To Host	32	Fault	To Host
15	Not Used		33	Not Used	
16	Logic Gnd		34	Not Used	
17	FG	Frame Gnd	35	Not Used	
18	+5V (z=24k ohm)	To Host	36	SelectIn ₁	From Host

1 Signals required for ieee 1284 mode.

UNIVERSAL SERIAL BUS (USB) ADAPTER

The Universal Serial Bus (USB) interface is a Plug-In Interface Module that can be installed by the user. It requires a driver (shipped with each printer that has the interface installed) that must be loaded on your PC and the PC must be configured to support USB peripherals using Windows 98 or above. Details for loading the USB driver are contained in the USB Interface Manual that is shipped with each printer with a USB Optional interface installed. Up to 127 devices may be connected to a USB port using powered hubs.

SPECIFICATIONS	
Printer Connector	USB Type B Plug
Cable	10 feet (3 m) maximum
Host	Windows 98 or above with USB Port
Power Supply	BUS Power through cable
Power Consumption	+5 V at 80 ma

LOCAL AREA NETWORK (LAN) ETHERNET

A Local Area Network (LAN) interface is an optional Plug-In Interface Module that can be installed by the user. It requires a driver shipped with each printer that has the interface installed. The driver that must be loaded on your PC and the PC must be configured to run one of the supported network protocols using a 10/100BaseT LAN connection. Details for loading the LAN driver are contained in the LAN Interface Manual that is shipped with each printer with a LAN Optional interface installed.

SPECIFICATIONS	
Connector	RJ-45 Receptacle
Cable	10/100BaseT Category 5
Power Supply	Powered from printer

802.11B WIRELESS

The wireless print server provides easy printer interface with 802.11b Wi-Fi compliant networks free of wired connections. Each printer is shipped with an integrated driver and interface installed. The driver must be loaded on your PC and the PC must be configured to run one of the supported protocols.

802.11B WIRELESS SPECIFICATIONS	
Variable Data Rates	11, 5.5, 2 and 1 Mbps
Frequency Band	2.4 GHz ISM Band
Wired Equivalent Privacy	128 bit, 64 bit (compatible with 40bit), none
Sensitivity	(typ, AAWGN, 8E-2 PER): -91dBm at 1Mbps, -88dBm at 2 Mqps, -87dBm at 5.5Mbps, -84dBm at 11Mbps.
Range	100m indoors, 300m outdoors
Protocols	TCP/IP, IPX/SPX, Direct Mode IPX/IP, DLC/LLC, NetBEUI, NetBIOS/IP

RECEIVE BUFFER

The data stream is received from the host to the printer one job at a time. This allows the software program to maintain control of the job print queue so that it can move a high priority job in front of ones of lesser importance.

A multiple job buffer allows the printer to continuously receive print jobs while compiling and printing other jobs at the same time. It acts much like a Print buffer to maximize the performance of the host and the printer.

The printer receives and prints one job at a time. If a print job exceeds the buffer size, transmission will be rejected by the printer. Flow control protocols to throttle transmission are not used. Error conditions that occur during the Print Data transmission will cause the printer to return a NAK.

ACK/NAK PROTOCOL

Bi-Directional ACK/NAK protocol is used for error control. In a normal transmission sequence when the transmission is received, the printer will return an ACK (06H) signifying that it was received without a transmission error. After the transmission command structure has been analyzed, a status byte is returned to the host. This status byte informs the host of the validity of the command structure.

If the command structure is error free, the printer proceeds with the print operation. When the print operation is completed, a Printer Status message is returned to the host. If an error was detected during the initial transmission sequence, a NAK (15H) will be returned signalling to the host that the received transmission contained errors and must be resent. If the returned Status byte indicates a command structure error, the error must then be corrected before the print data is resent to the printer.

A valid transmission to the printer must be bounded by an STX/ETX pair, with the STX (02H) signifying the start of the Print Data and ending with an ETX (03H) signifying the end.

ACCESSORIES INSTALLATION

EXTERNAL SIGNAL CONNECTOR

This connector permits the interface of an external source with the printer for the purpose of regulating print activity to coincide with those external requirements (i.e.: production flow, etc.).

- 1 Disconnect power supply cord and remove the rear housing cover (1, Figure 3-6).
- 2 Remove screw (2) and plate (3) as required to expose the EXT port.
- 3 Remove two screws (4) and withdraw existing board (5) from frame (6) as required.

NOTE: The above step only applies if replacing an existing board.

- 4 Insert external signal board (5) into slot in frame (6) and secure using two screws (4).
- 5 Connect the interface cord, power cord, and reinstall rear housing covers.

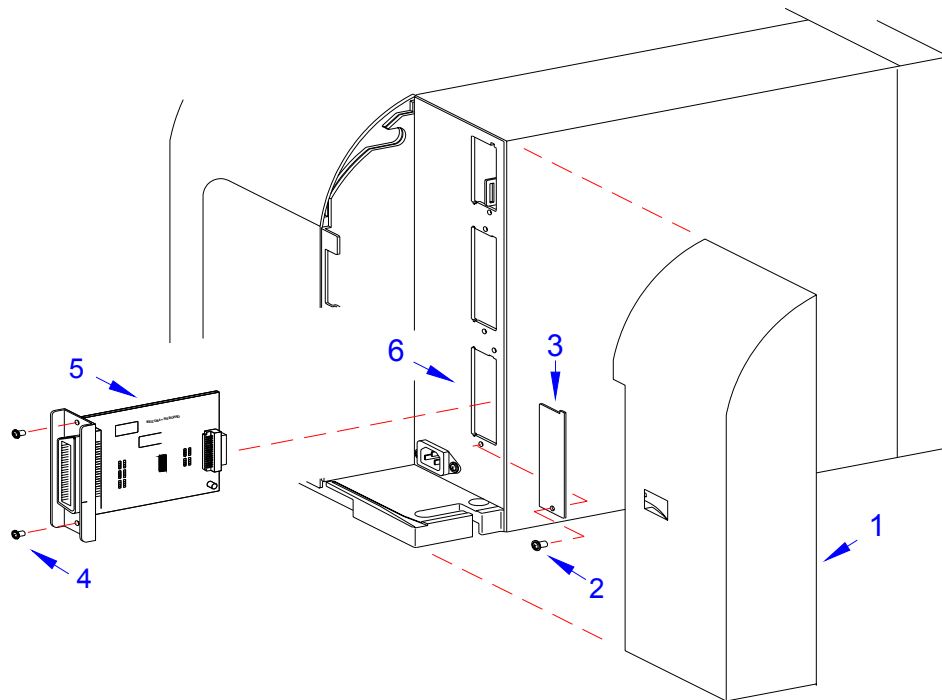

Figure 3-6, External Signal Connector

MEMORY EXPANSION

The memory cartridge provides additional storage of user data and graphics. Access to the memory cartridge port, and its installation, is very simple. The instructions below provide guidance.

CAUTION: INSTALL THE MEMORY CARTRIDGE PRIOR TO SENDING RELATIVE COMMANDS OR AN ERROR WILL OCCUR. REMOVE POWER TO THE PRINTER PRIOR TO INSTALLING THE CARTRIDGE.

- 1 Disconnect power supply cord.
- 2 Detach memory cartridge cover (1, Figure 3-7) from center frame (2).
- 3 Fully insert memory cartridge (3) into its respective port and replace cover (1).
- 4 Restore power to the printer and send commands.

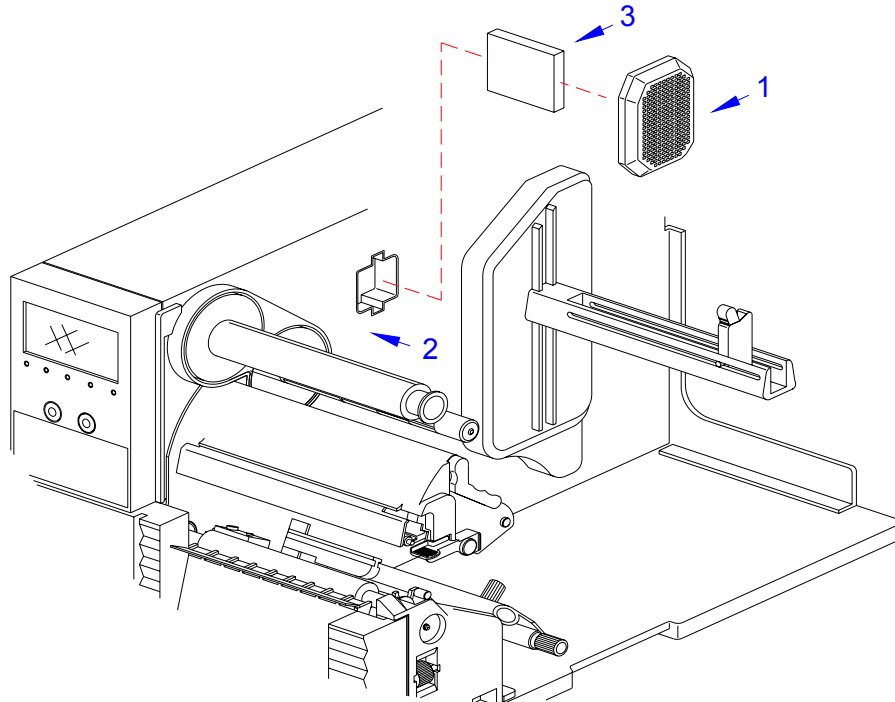

Figure 3-7, PCMCIA Memory Expansion

INTERFACE UPGRADE

The printer is typically ordered with a high-speed parallel interface board installed. However, interface requirements sometimes change and an upgrade is desired. All of the interface boards are installed within the same slot (middle) located in the rear of the printer with little or no difference in installation methodology with the exception of the mini-LAN interface (top slot).

Parallel Interface (IEEE1284)	(Optional or Bundled)
Serial Interface (RS232C)	(Optional)
USB Interface	(Optional)
10BaseT/100Base-TX Lan Interface	(Optional)
Wireless LAN 802.11b Interface	(Optional)
10BaseT/100Base-TX mini LAN	(Optional)
EXT Connector (External Signal Interface)	(Optional)

- 1 Remove the rear housing cover (1, Figure 3-8). Disconnect the power and interface cords.
- 2 Remove screw (2) and plate (3) as required to expose the interface port.
- 3 Remove two screws (4) and withdraw existing board (5) from frame (6) as required.
- 4 Insert replacement board (5) into slot in frame (6) and secure using two screws (4).
- 5 Connect the interface cord, power cord, and reinstall rear housing covers.

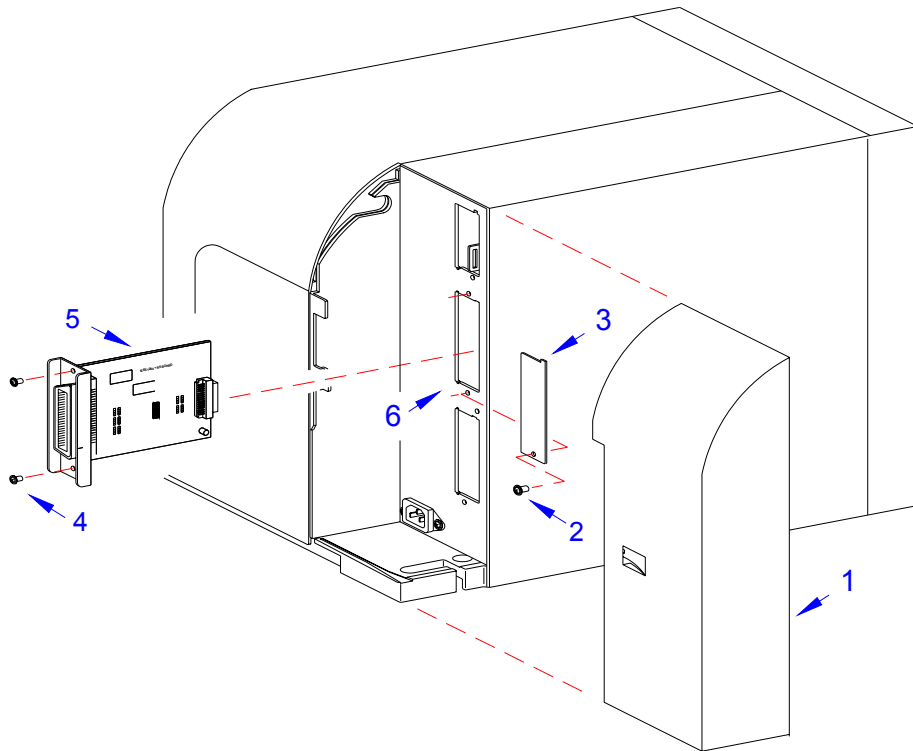

Figure 3-8, Interface Upgrade

LABEL CUTTER INSTALLATION

The label cutter, when installed, replaces the printer's lower front housing cover. Its internal sensor monitors media feed and activates the cut sequence based on user established values.

The cutter assembly is powered through relayed current from the printer's power supply and derives its primary intelligence from the main circuit board. The activated cut sequence severs the printed media from the unprinted media allowing the operator to retrieve and apply at will.

Installation instructions are provided with the purchased product.

LABEL PEELER INSTALLATION

The label peeler, when installed, replaces the printer's lower front housing cover. As the label is printed and fed forward, the peel bar separates the printed label from its paper backing and presents it for application. When the printed label is retrieved by the operator, the printer feeds the unprinted media back into position for another print sequence. The cycle is again repeated.

Installation instructions are provided with the purchased product.

4

PRINTER OPERATION

- **Configuration Modes**
- **Operational Adjustments**

CONFIGURATION MODES

This chapter provides an overview of the various configuration modes of the operation menu. All of the following configuration activities are performed via the use of the operator panel located on the printer front. However, many settings may also be controlled via software commands. In the case of conflict between the software and control panel settings, the printer will always use the last entered valid setting.

NORMAL MODE

When a print job is received, the LCD will display the number of labels to be printed and will numerically descend as each label is printed.

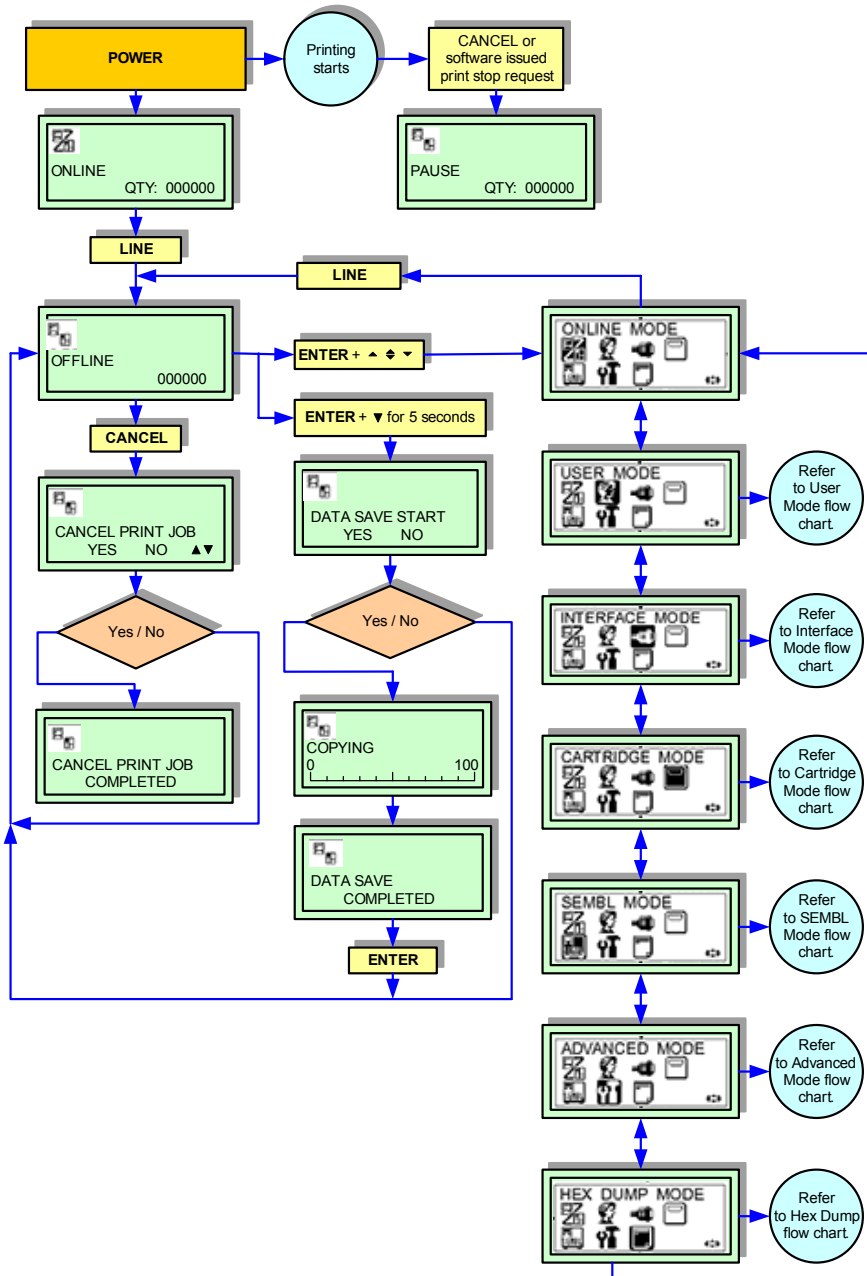

Figure 4-1, Normal Mode

USER MODE

This mode allows configuration of printing features that are prone to change from job to job. These are some of the most basic and common adjustments of all of the configuration modes.

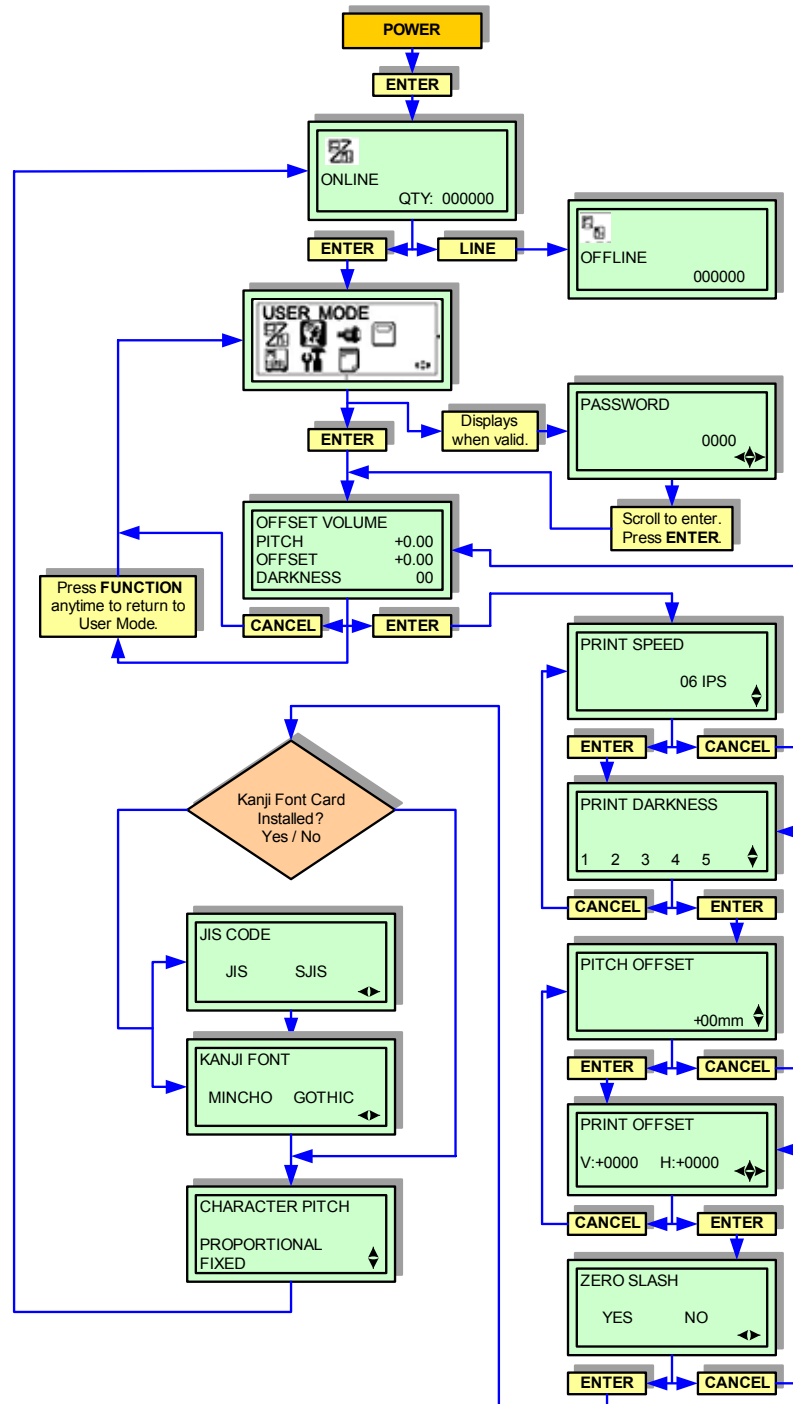

Figure 4-2, User Mode

ADVANCED MODE

The Advanced Mode is provided to make basic printer operational adjustments. Typically, once these adjustments or settings have been made, they will not require additional address unless a new job is downloaded. The following table identifies the menus of the Advanced Mode and their purpose.

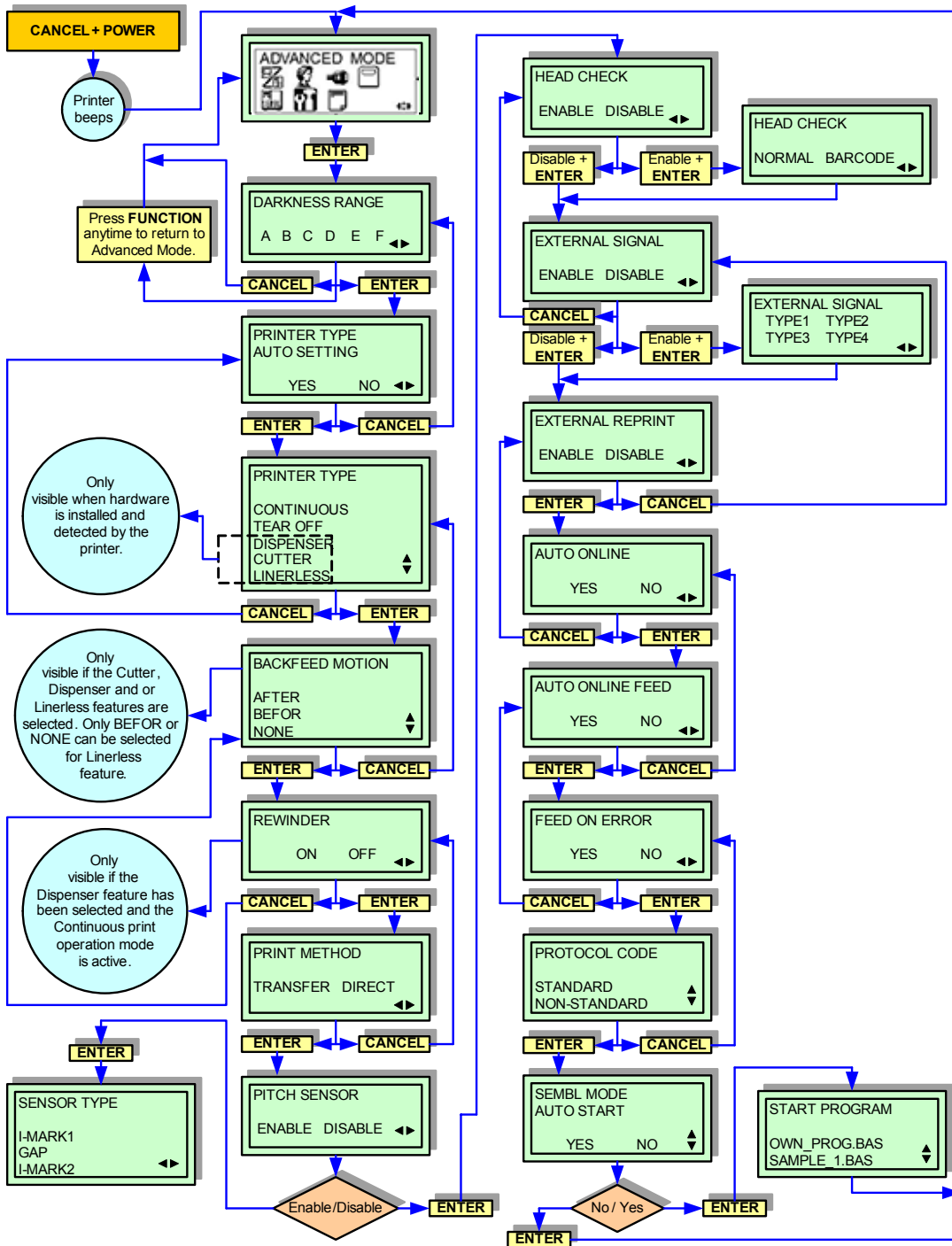

Figure 4-3, Advanced Mode

IEEE1284 INTERFACE SETUP MODE

This chapter provides the programming sequences required for IEEE1284 interface setup. Use the keys of the printer's operator panel to select and enter the required options.

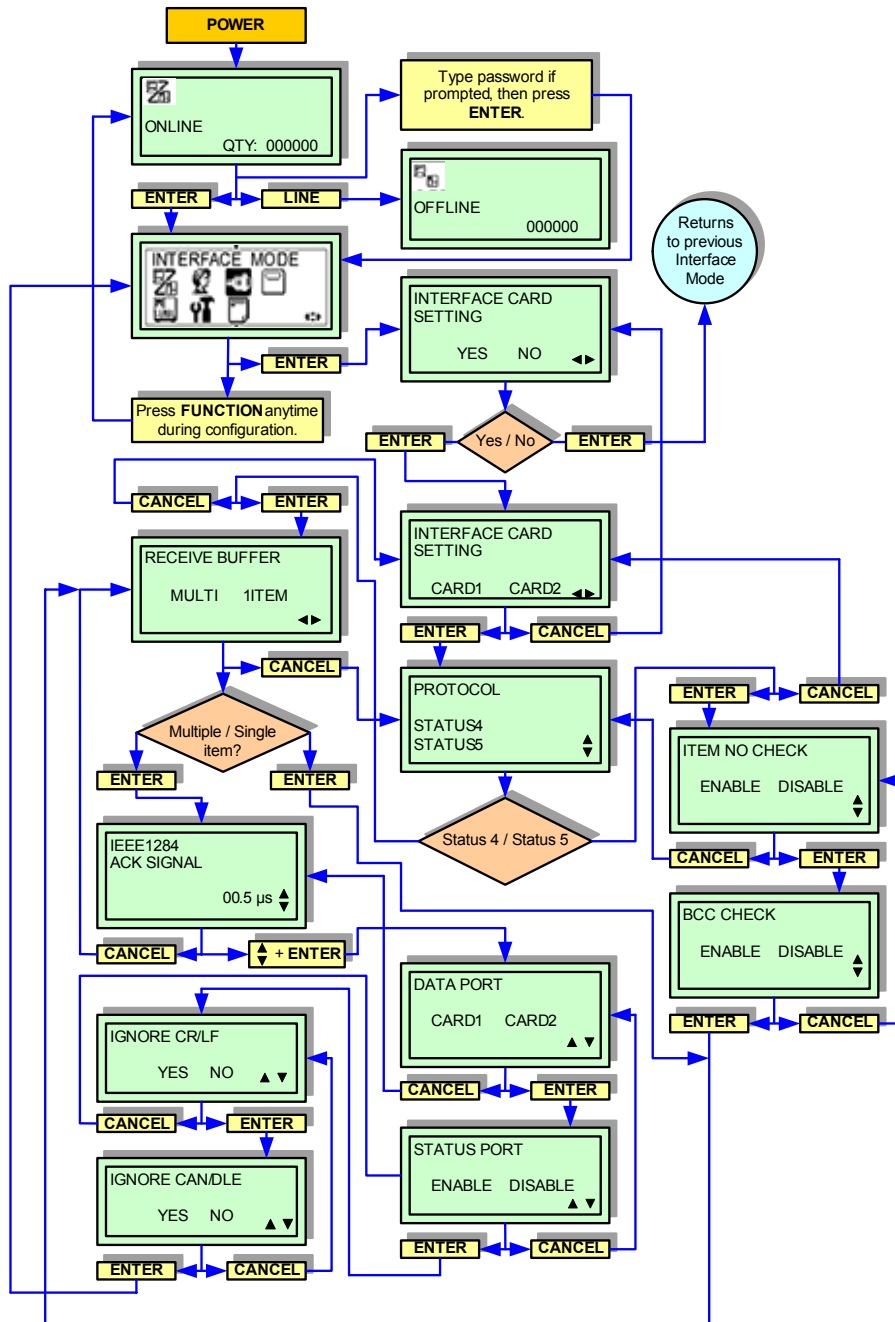

Figure 4-4, IEEE1284 Interface Setup Mode

RS232C INTERFACE SETUP MODE

This chapter provides the programming sequences required for RS232C interface setup. Use the keys of the printer's operator panel to select and enter the required options.

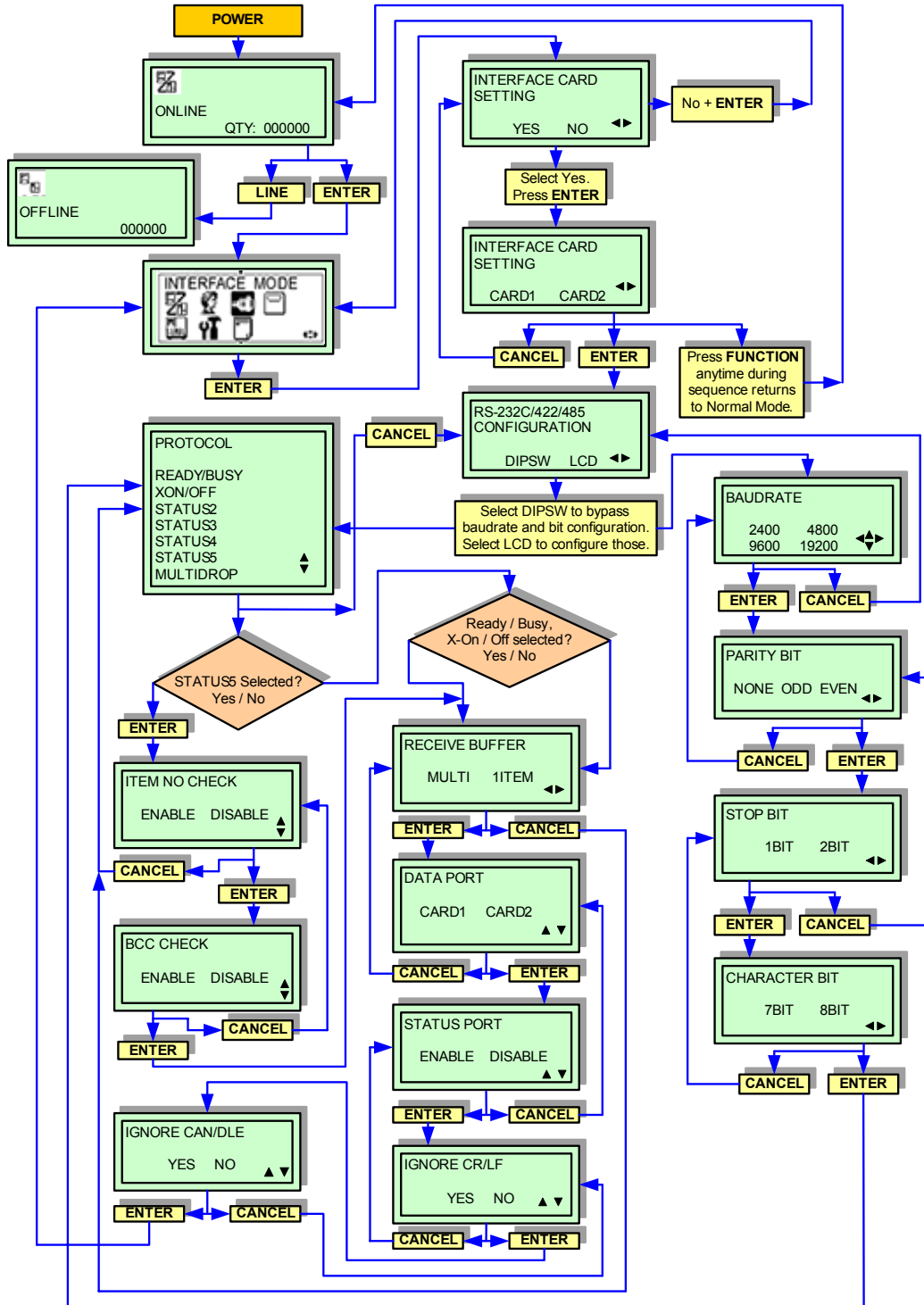

Figure 4-5, RS232C Interface Setup Mode

CENTRONICS INTERFACE SETUP MODE

This chapter provides the programming sequences required for Centronics interface setup. Use the keys of the printer's operator panel to select and enter the required options.

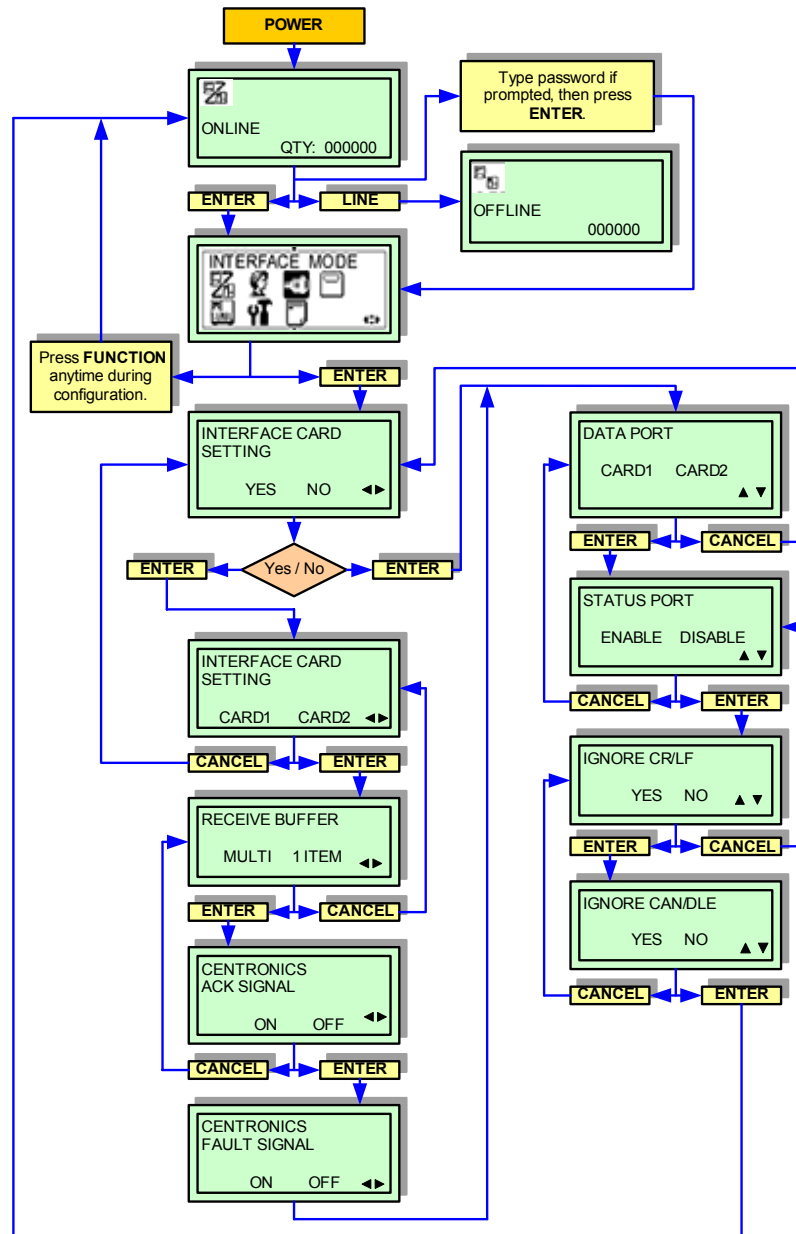

Figure 4-6, Centronics Interface Mode

LAN INTERFACE SETUP MODE

This chapter provides the programming sequences required for LAN and mini-LAN interface setup. Use the keys of the printer's operator panel to select and enter the required options.

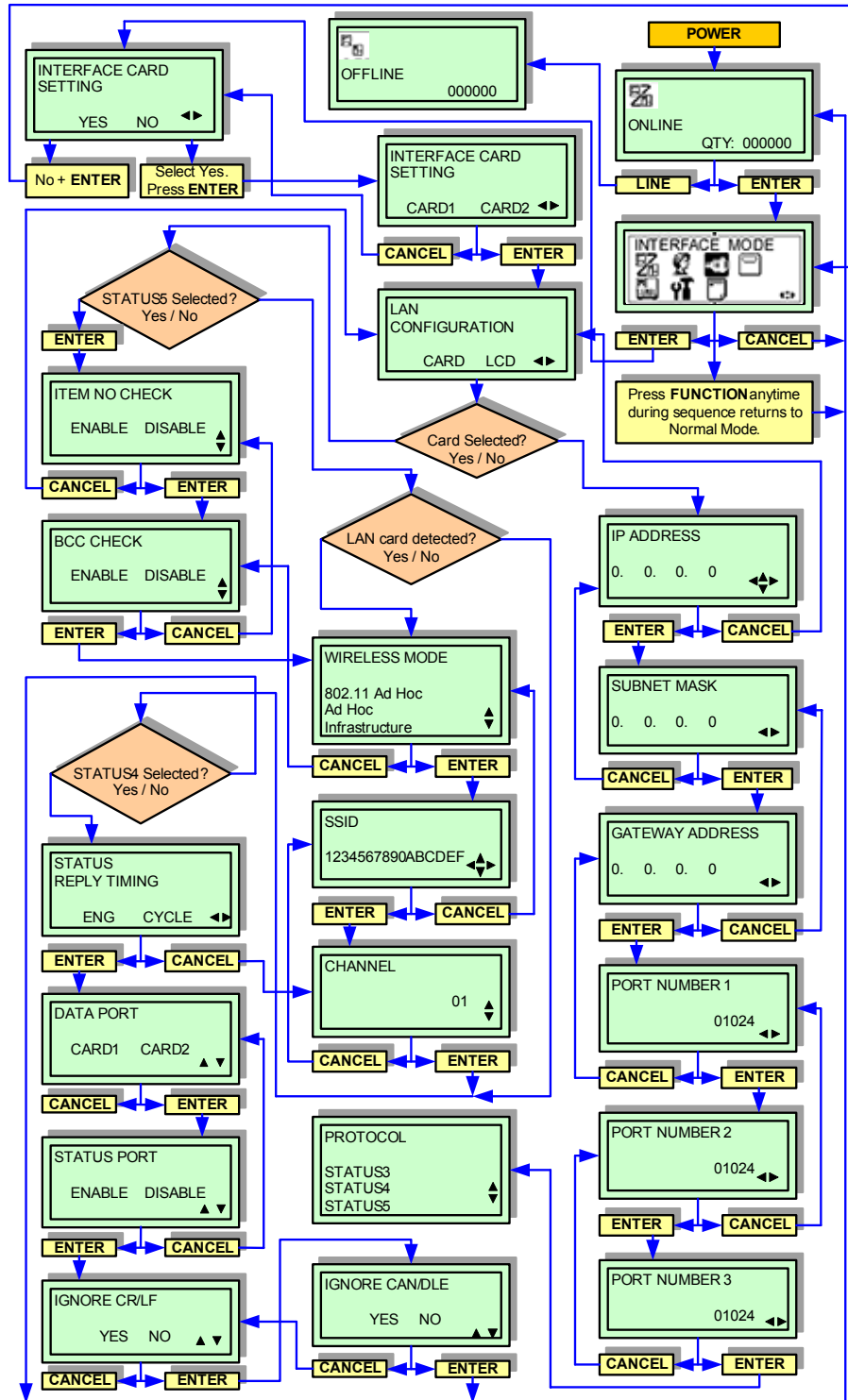

Figure 4-7, LAN Interface Setup Mode

USB INTERFACE SETUP MODE

This chapter provides the programming sequences required for USB interface setup. Use the keys of the printer's operator panel to select and enter the required options.

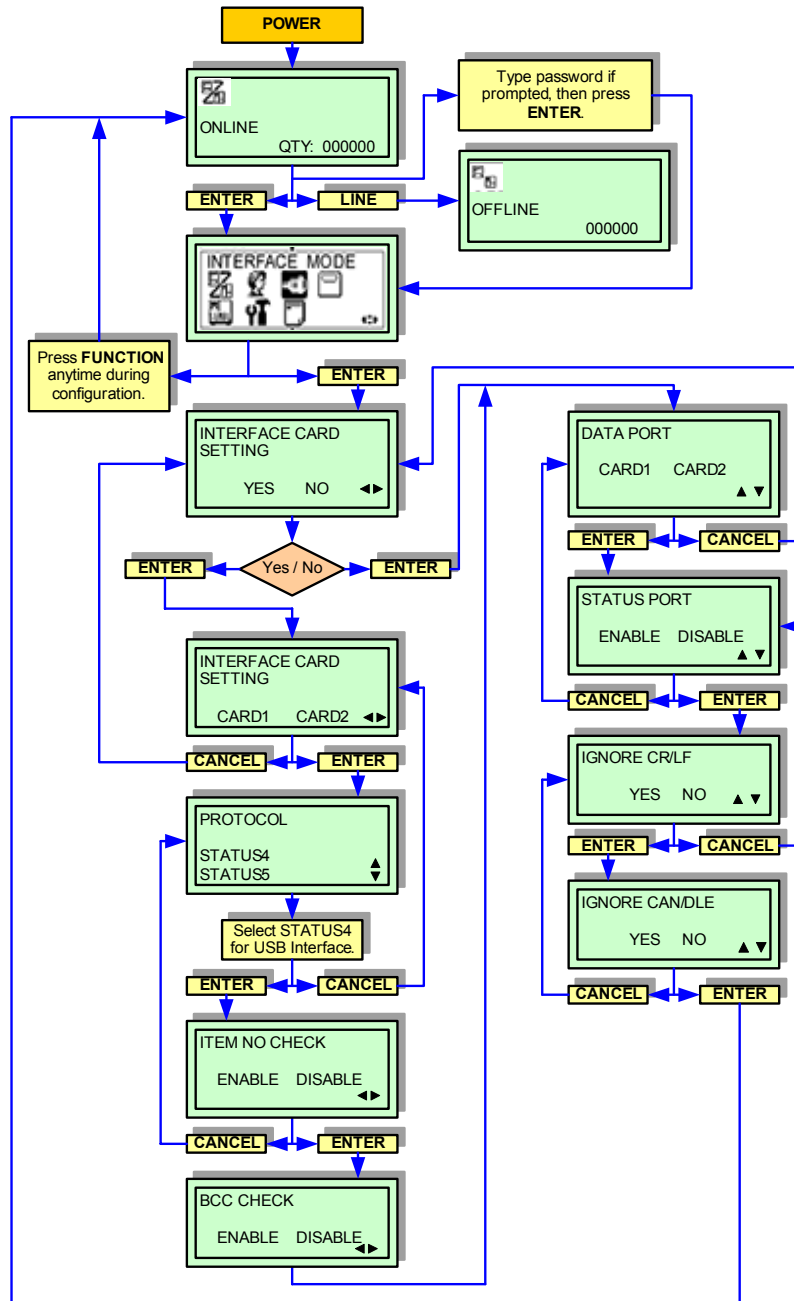

Figure 4-8, USB Interface Setup Mode

CARTRIDGE MODE

This mode permits the configuration of an optional memory cartridge. This cartridge, when loaded, provides increased storage capacity for text and graphics. Use the keys of the printer's operator panel to select and enter the required options.

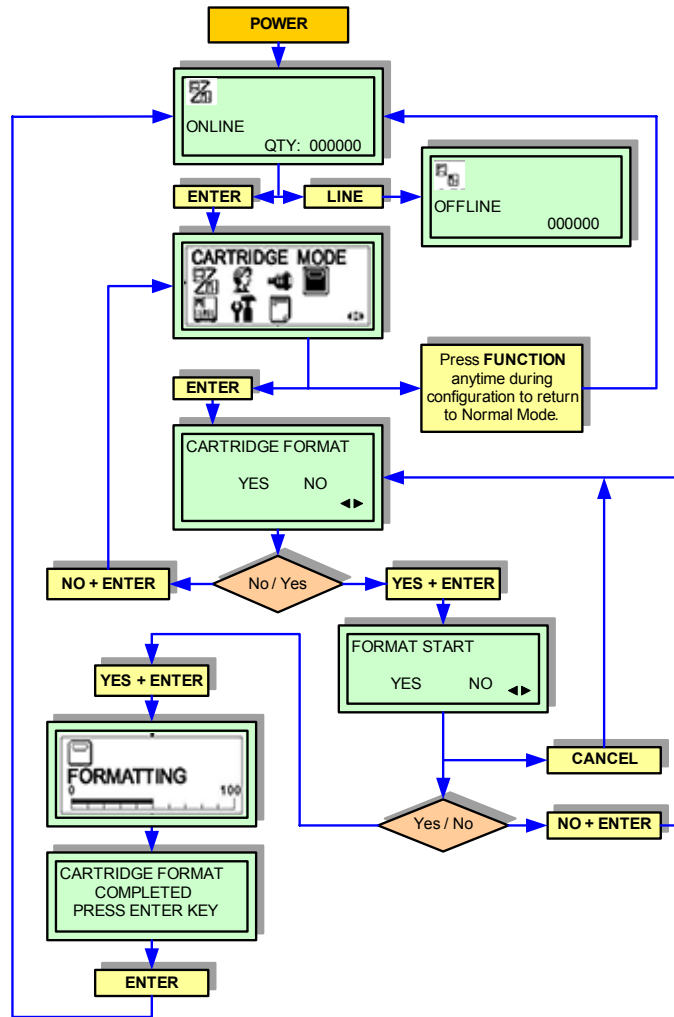

Figure 4-9, Cartridge Mode

SEMBL MODE

SEMBL (SATO Embedded Basic Language) allows software programs written in standard Basic language to be loaded into the printer and executed without additional computer connections.

Use the keys of the printer's operator panel to select and enter the required options.

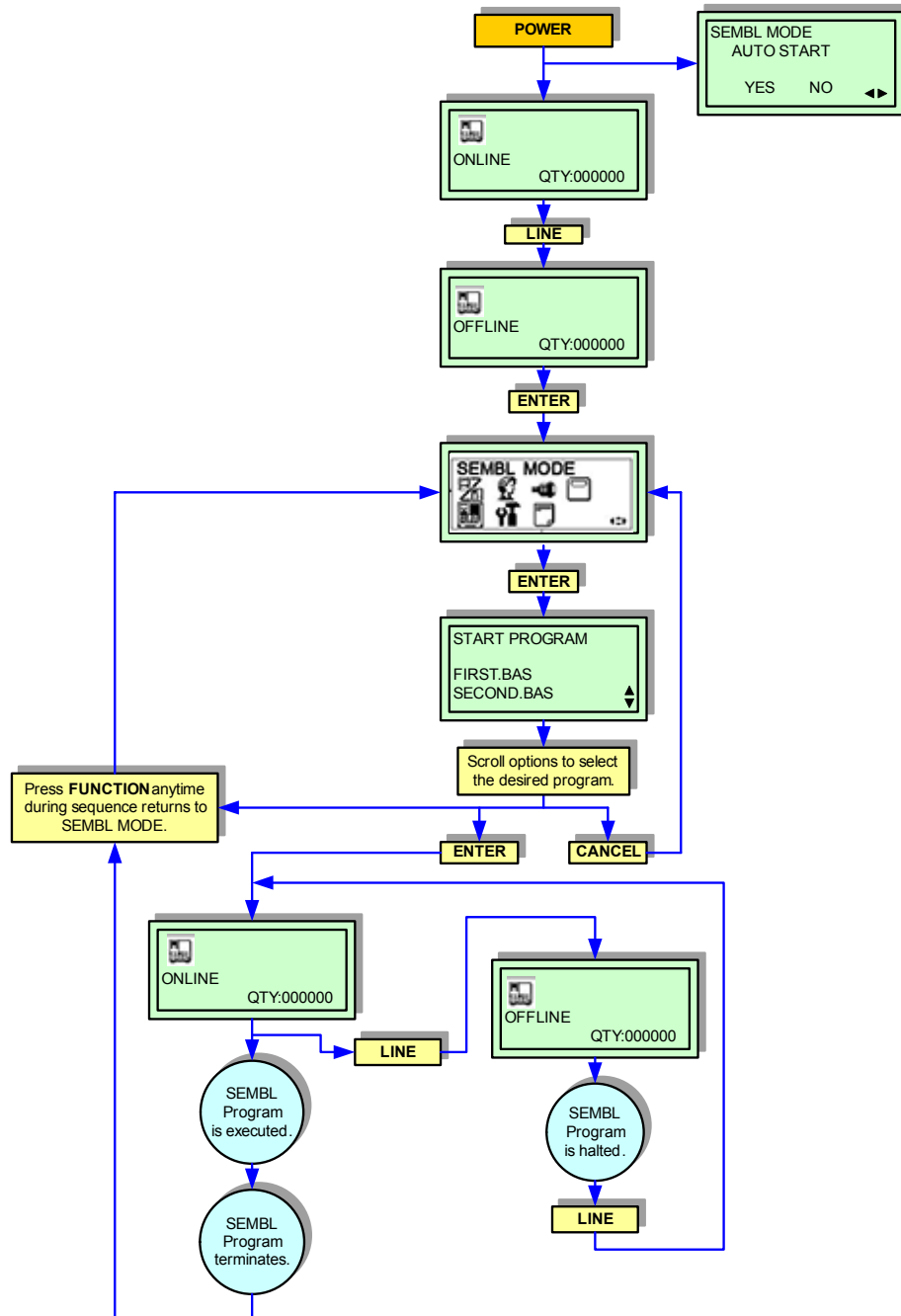

Figure 4-10, SEMBL Mode

TEST PRINT MODE

Figure 4-11 provides the specific sequence of events required by the operator, the printer, and the printer's software for a test label to be printed. Test labels are designed to identify failures in configuration, adjustment problems, and mechanical defects.

Use the keys of the printer's operator panel to select and enter the required options.

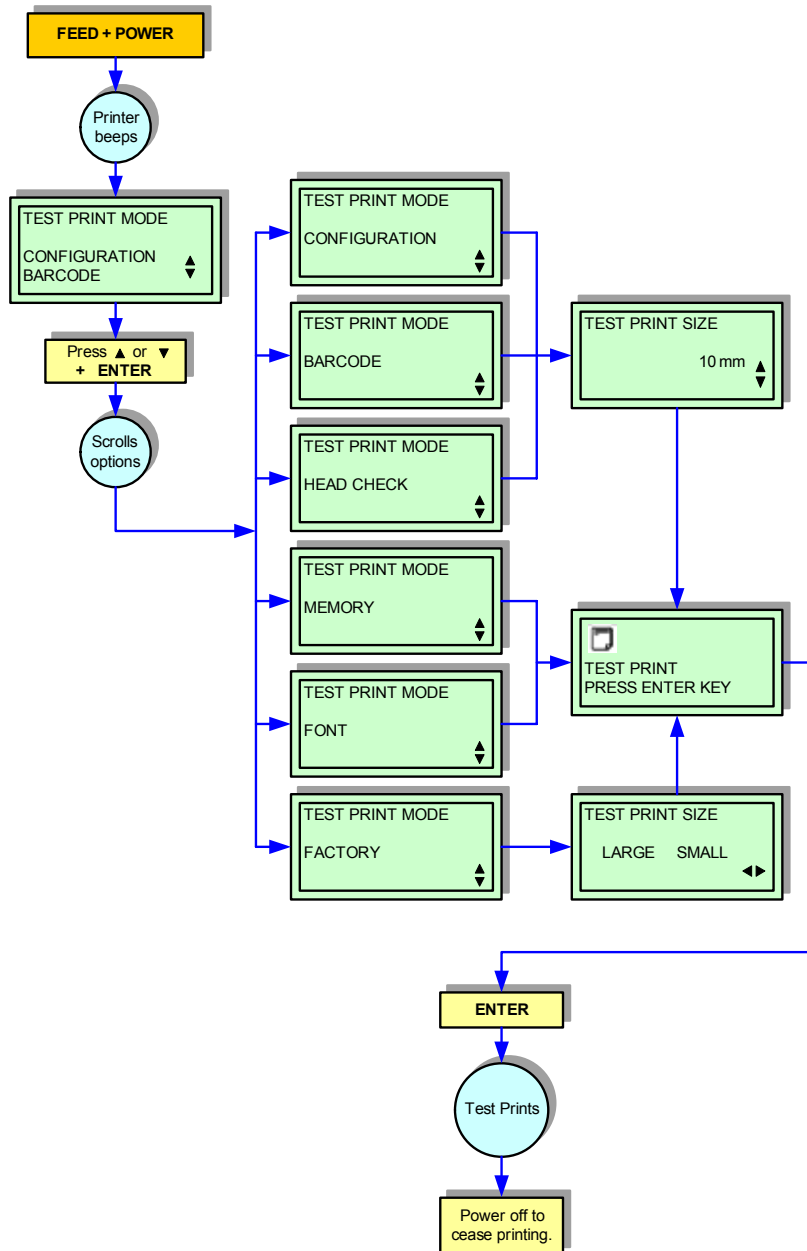

Figure 4-11, Test Print Mode

DOWNLOAD MODE

This download feature allows the operator to download print jobs to the printer. When downloading is complete, the LCD screen will return to the original display. If an error occurs, a DOWNLOAD ERROR will display.

Use the keys of the printer's operator panel to select and enter the required options.

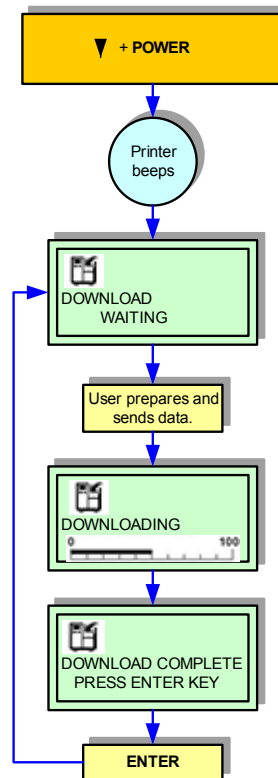

Figure 4-12, Download Mode

HEX DUMP MODE

The contents of the print buffer and the data received before it is placed into the print buffer may be examined through the use of the Hex Dump Mode. Each line of the printed data is inumerated in the first column, the second column contains the data in hexadecimal format, and the right column contains the same data in ASCII format.

Only one type of data may be printed on a single label. Repeat the dump process to print the other data type.

Use the keys of the printer's operator panel to select and enter the required options.

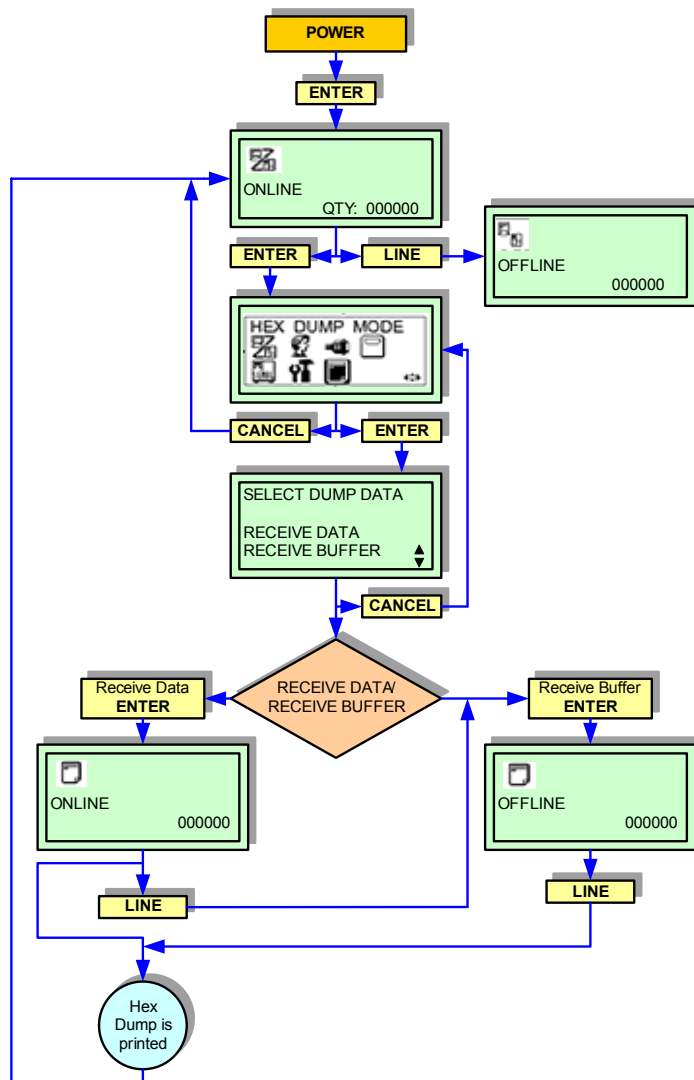

Figure 4-13, Hex Dump Mode

BOOT DOWNLOAD MODE

Figure 4-14 provides the specific sequence of events required by the operator, the printer, and the printer's software. Use the keys of the printer's operator panel to select and enter the required options.

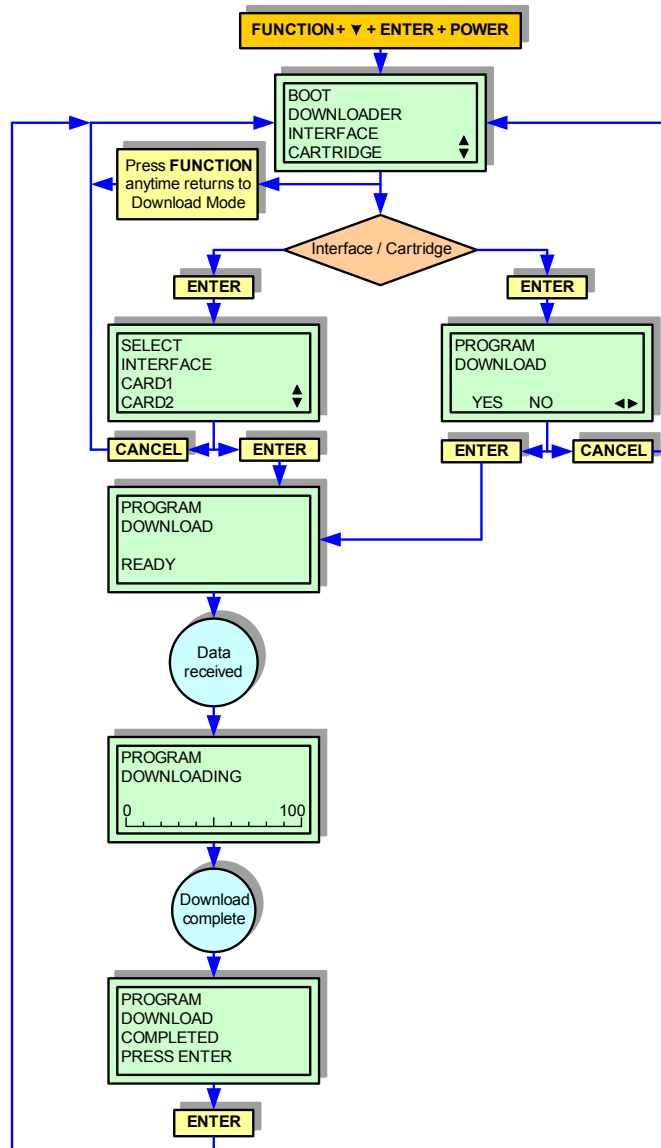

Figure 4-14, Boot Download Mode

DATA SAVE MODE

Figure 4-15 provides the specific sequence of events required by the operator, the printer, and the printer's software to store the printer's history.

Use the keys of the printer's operator panel to select and enter the required options.

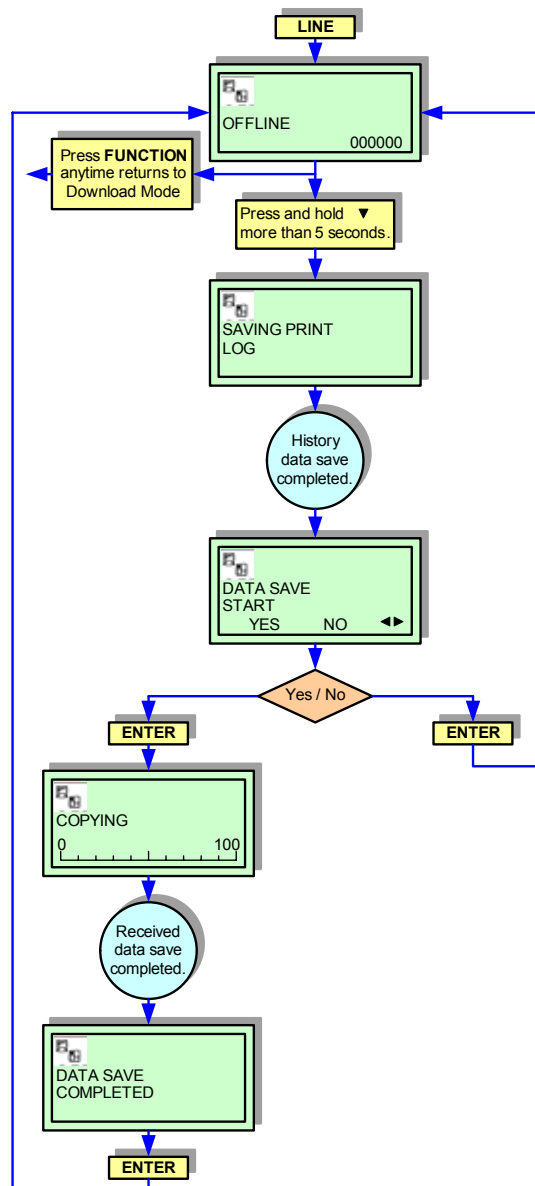

Figure 4-15, Data Save Mode

DEFAULT SETTINGS MODE

Figure 4-16 provides the specific sequence of events required by the operator, the printer, and the printer's software to return the printer to the configuration state as received from the factory.

Use the keys of the printer's operator panel to select and enter the required options.

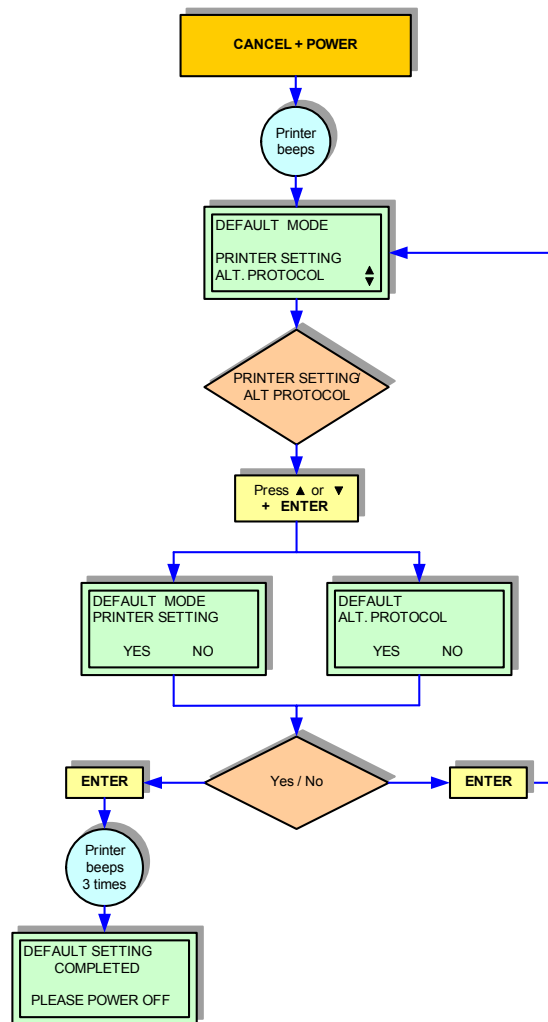

Figure 4-16, Default Settings Mode

PRINT CANCEL MODE

Figure 4-17 provides the specific sequence of events required by the operator, the printer, and the printer's software to cancel a print job once initiated. Use the keys of the printer's operator panel to select and enter the required options.

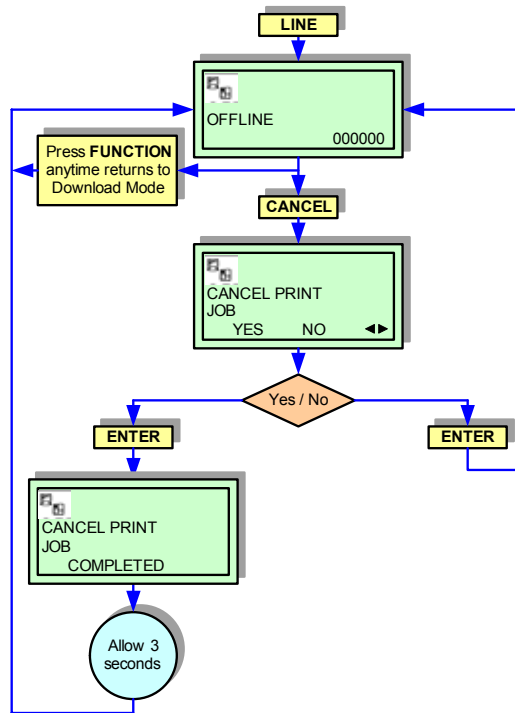

Figure 4-17, Print Cancel Mode

PRINT DARKNESS DEFAULT MODE

Figure 4-18 provides the specific sequence of events required by the operator, the printer, and the printer's software to return to the print darkness (density) setting as received from the factory.

Use the keys of the printer's operator panel to select and enter the required options.

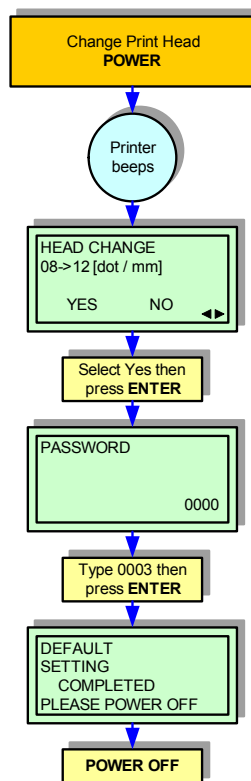

Figure 4-18, Print Density Default Mode

SERVICE MODE

Allows the programming of various dimensional settings, sensor thresholds, and language options. Use the keys of the printer's operator panel to select and enter the required options.

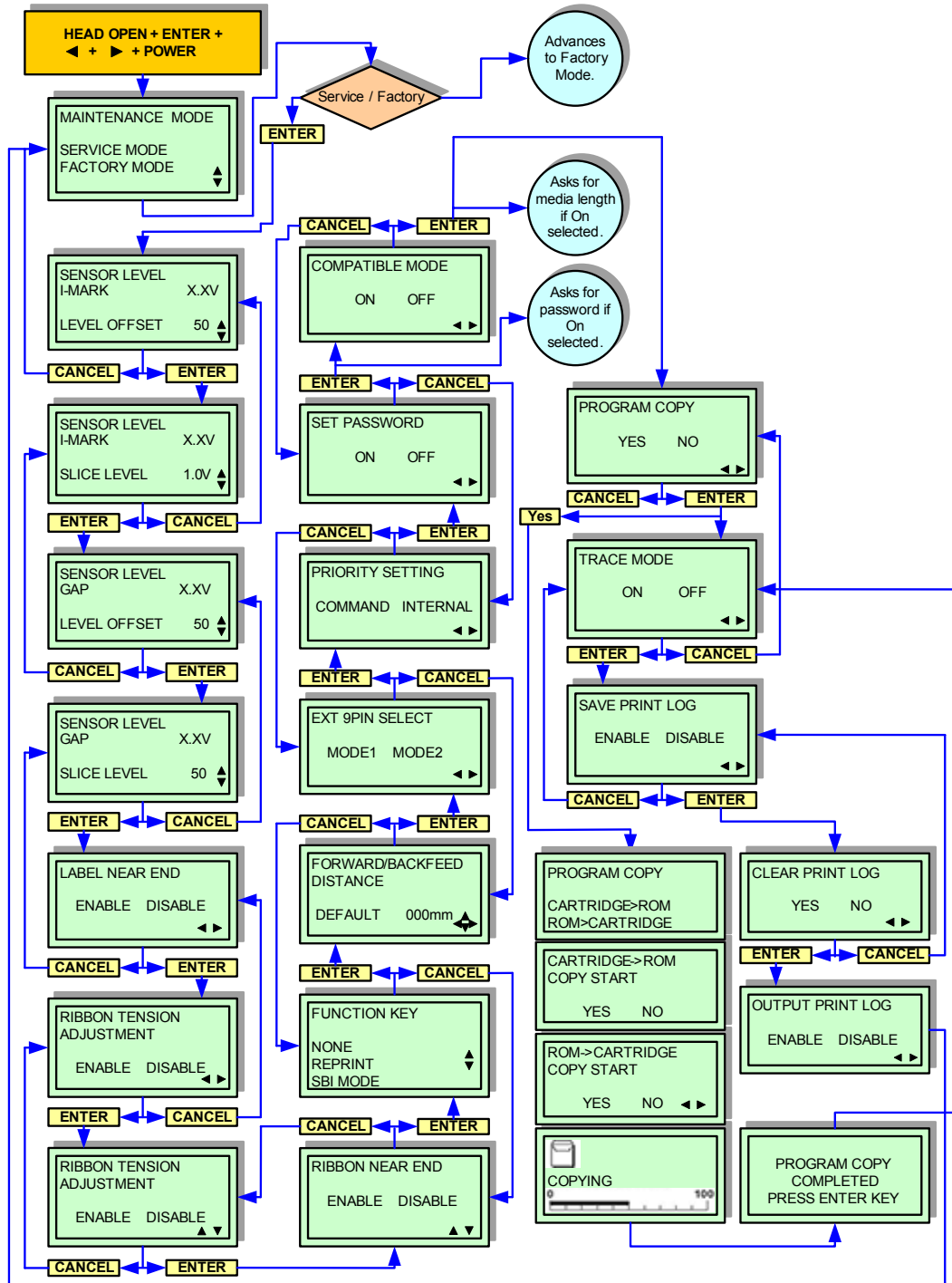

Figure 4-19, Service Mode

FACTORY MODE

The Factory Mode permits counter reset of various printer components. Use the keys of the printer's operator panel to select and reset those features.

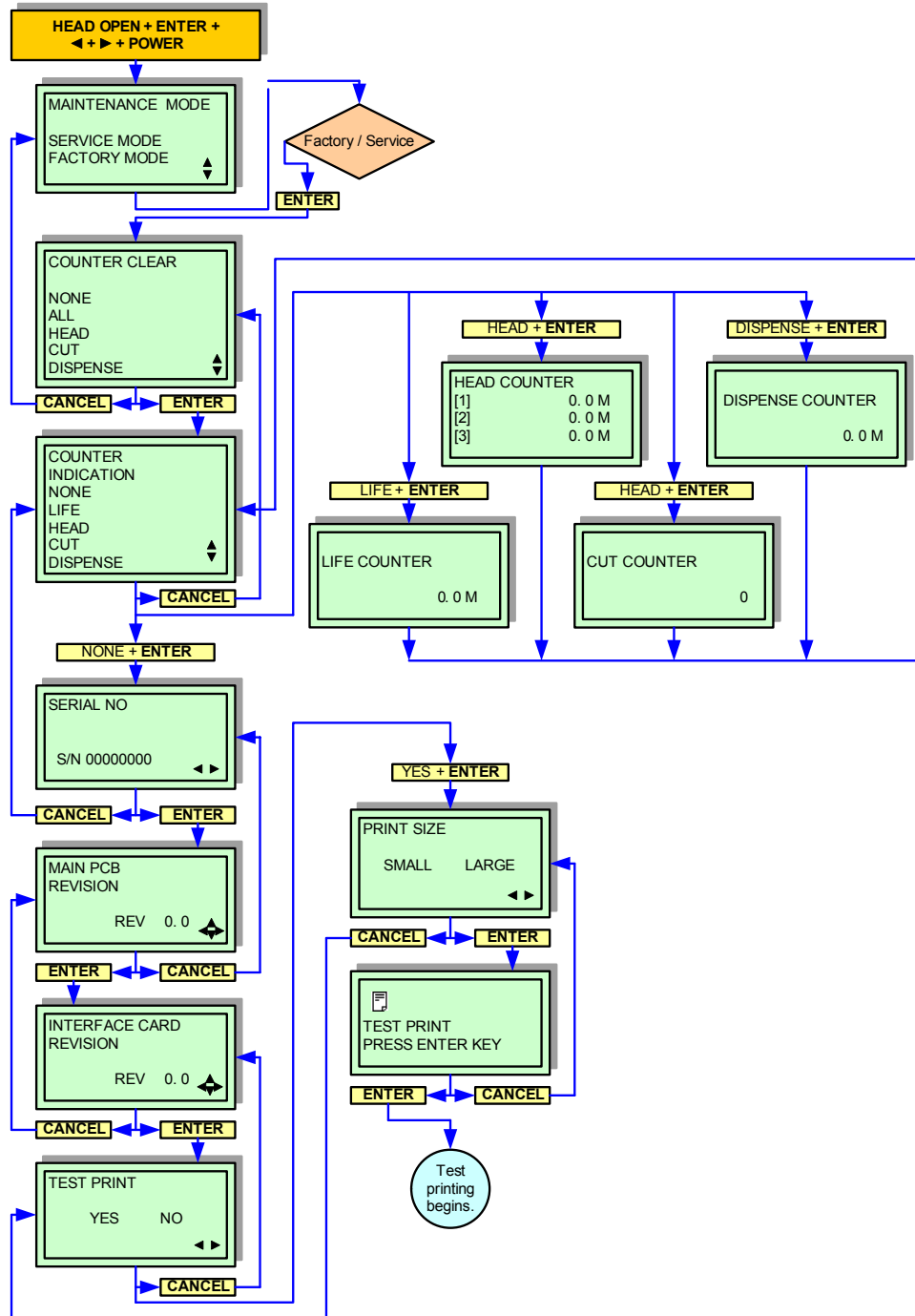
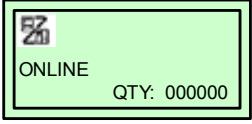
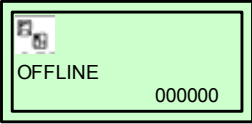

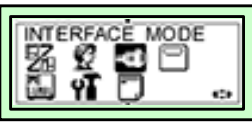
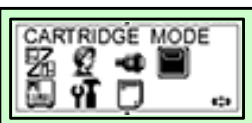
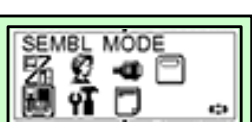

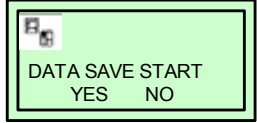
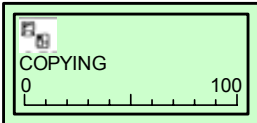
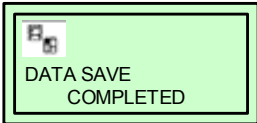
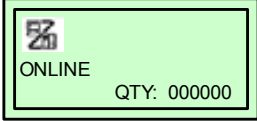
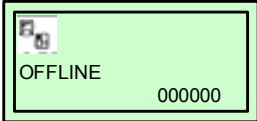

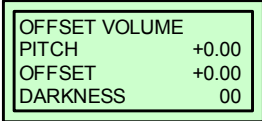
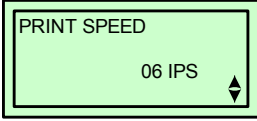
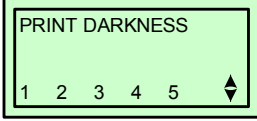
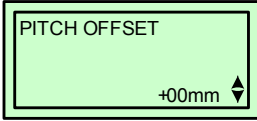
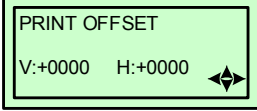
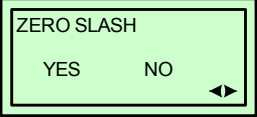
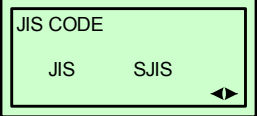

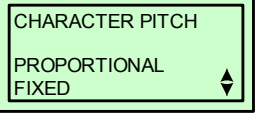

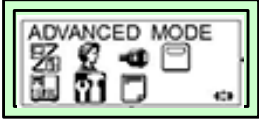

Figure 4-20, Factory Mode

NORMAL MODE (4-1)	
MENU	DESCRIPTION
	<p>Displays the operational status of the printer. The ONLINE status is displayed on the top line and the label quantity status on the bottom. The message will be changed to OFFLINE whenever the printer is switched offline by pressing the LINE key. When a print job is received, the quantity line will indicate the number of labels to be printed. As the label job prints, the display indicates the number of labels remaining to be printed.</p>
	<p>Displays the operational status of the printer. The OFFLINE status is displayed on the top line and the label quantity status on the bottom. The message will be changed to ONLINE whenever the printer is switched online by pressing the LINE key.</p>
	<p>Is the first screen of the Normal Mode. Allows indepth analysis of the printer's status.</p>
	<p>Is the premiere screen of the User Mode. The User Mode allows various print parameters to be set.</p>
	<p>Is the premiere screen of the Interface Mode. Interface Mode allows the parameters to be set for the printer to communicate with a host and vise-versa.</p>
	<p>Is the premiere screen of the Cartridge Mode. Permits setup and use of the memory cartridge.</p>
	<p>Is the premiere screen of the SEMBL Mode. SEMBL (SATO Embedded Basic Language) allows software programs written in standard Basic language to be loaded into the printer and executed without additional computer connections.</p> <p>Use the keys of the printer's operator panel to select and enter the required options.</p>

NORMAL MODE (4-1)	
MENU	DESCRIPTION
	<p>Is the premiere screen of the Advanced Mode. The Advanced Mode is provided to make basic printer operational adjustments. Typically, once these adjustments or settings have been made, they will not require additional address unless a new job is downloaded. The following table identifies the menus of the Advanced Mode and their purpose.</p>
	<p>Is the premiere screen to the Hex Dump Mode. The contents of the print buffer and the data received before it is placed into the print buffer may be examined through the use of the Hex Dump Mode. Each line of the printed data is inumerated in the first column, the second column contains the data in hexadecimal format, and the right column contains the same data in ASCII format.</p>
	<p>Allows the status of the receive buffer to be saved to the memory cartridge. If the YES option is chosen, a cofiguration screen will then be displayed. If the NO option is selected, the printer goes offline without saving.</p>
	<p>This screen shows the status of saving the receive buffer to the memory cartridge. Data entry is not required.</p>
	<p>This screen confirms the receive data was saved. Press ENTER key to go offline.</p>

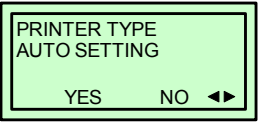
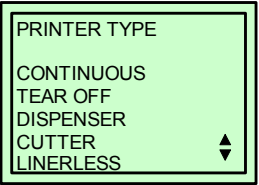
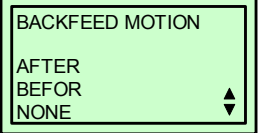
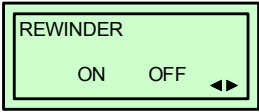
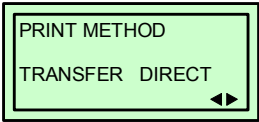

USER MODE (4-2)	
MENU	DESCRIPTION
	<p>Displays the operational status of the printer. The ONLINE status is displayed on the top line and the label quantity status on the bottom. The message will be changed to OFFLINE whenever the printer is switched offline by pressing the LINE key. When a print job is received, the quantity line will indicate the number of labels to be printed. As the label job prints, the display indicates the number of labels remaining to be printed.</p>
	<p>Displays the operational status of the printer. The OFFLINE status is displayed on the top line and the label quantity status on the bottom. The message will be changed to ONLINE whenever the printer is switched online by pressing the LINE key.</p>
	<p>Is the premiere screen of the User Mode. The User Mode allows various print parameters to be set.</p>
	<p>This screenshows the adjusted value for volume on the Operator Panel.</p>
	<p>Permits the printer's print speed to be established based on inches per second (IPS). The speed options available are dependent on the print head's resolution.</p>
	<p>Permits the adjustment of the print density. Higher print density equates to darker print images.</p>
	<p>The label pitch is the distance from the leading edge (the edge that comes out of the printer first) of a label and the leading edge of the next label. Once the position has been set, it can be fine adjusted using the PITCH potentiometer.</p> <p>Positive (+) digit selection on the display moves the leading edge forward and away from the print head while a negative (-) selection moves the label's leading edge incrementally back into the mechanism.</p>

USER MODE (4-2)	
MENU	DESCRIPTION
	<p>Print offset refers to the vertical and horizontal shifting of the entire print area relative to the label and the print start position. The movement is incremented by dots in the positive (+) or negative (-) direction. Positive and negative vertical adjustment is toward and away from the print head respectively. Positive and negative horizontal adjustment is to the left or right of the reference point respectively.</p>
	<p>This menu allows for the printer to be configured to print zeros with or without a diagonal slash through them. This will apply to all font types with the exception of Kanji font.</p>
	<p>This menu allows printer configuration of Kanji files for either Japanese code (JIS) or Microsoft code (SJIS). If a Microsoft operating system is being used, SJIS is to be selected.</p>
	<p>Kanji font may be set to either Mincho or Gothic style. If unsure of their differences, refer to the Programming Reference for this printer.</p>
	<p>This setting determines whether each character occupies a designated space (fixed) regardless of the characters width or if the character's space is representative of the character's width (proportional). Proportional is contemporarily preferred.</p>

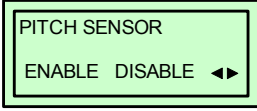
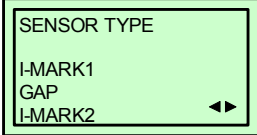
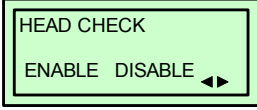
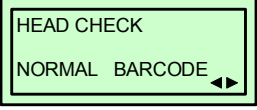
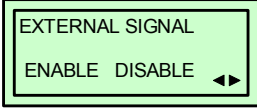
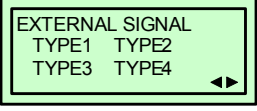
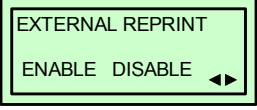
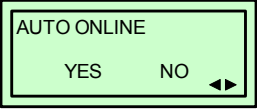

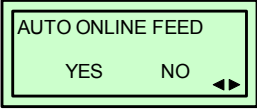
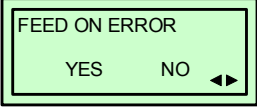
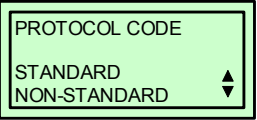
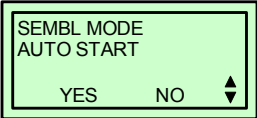
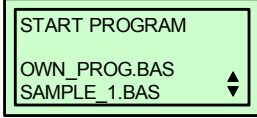
ADVANCED MODE (4-3)	
MENU	DESCRIPTION
	<p>Is the premiere screen of the Advanced Mode. The Advanced Mode is provided to make basic printer operational adjustments. Typically, once these adjustments or settings have been made, they will not require additional address unless a new job is downloaded. The following table identifies the menus of the Advanced Mode and their purpose.</p>
	<p>Allows the darkness (density) selection of the printed image. Has six selection options.</p>
	<p>Determines whether the printer automatically detects the installation of optional peripherals such as a peeler or cutter. If detected, the optional peripheral will be used without further configuration.</p>
	<p>Allows the choice of continuous feed or tear-off operation. If the relative accessories have been correctly installed, their respective options will be displayed.</p>
	<p>Allows the determination of wheather a backfeed motion will be applied. If so, the selection of before or after the printing of each label.</p>
	<p>Allows the internal rewinder option to be turned activated or deactivated as applicable.</p>
	<p>Allows the printer to be switched to operate in the thermal transfer or direct thermal mode as desired.</p>

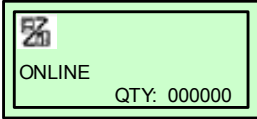
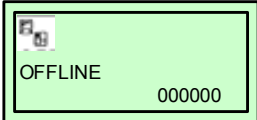
ADVANCED MODE (4-3)	
MENU	DESCRIPTION
	Allows the pitch sensor to be activated or deactivated as circumstances dictate.
	Allows the reference sensor to be selected relative to the media type to be used.
	This feature determines the integrity of the print head elements when enabled. A few labels will be printed before a print head error is displayed.
	This screen will appear if the head check feature has been selected. Choose for the head check to be performed unconditionally or only when barcodes are being printed. Previously printed barcodes should be scanned following an error to determine their functionality.
	Set this feature to enable or disable the printer's external signal communication port. If the port is enabled, data can be sent and received using an appropriate device plugged into the EXT port.
	Appears only if the printer's external signal feature has been enabled to allow selection of the output signal. For information on which type to choose, refer to the Programming Reference for guidance.
	Allows configuration as to whether the reprint function may be activated via the external signal port.
	The printer can be set to automatically go into the online mode when powered on. Otherwise, the printer starts in the offline state and must be manually placed online before it is ready to print.

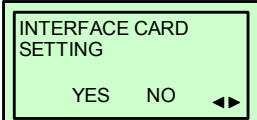
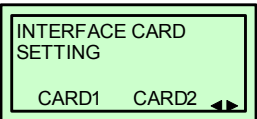
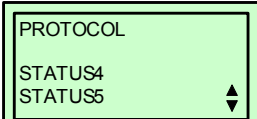
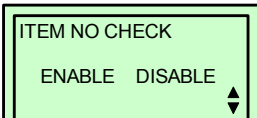
ADVANCED MODE (4-3)	
MENU	DESCRIPTION
	<p>This feature allows one label to be fed upon the printer being powered on. Enable or disable as desired.</p>
	<p>This feature allows one label to be fed following an error being corrected and the printer going online.</p>
	<p>The ESC sequence in SBPL commands may be defined as standard (using non-printable code 1BH) or non-standard (some other user code).</p>
	<p>The printer may be set to go to SEMBL Mode automatically (to execute a preloaded Basic program) upon being powered on.</p>
	<p>If the SEMBL Mode auto-start feature is enabled, this screen will appear to permit specification of the program to be executed.</p>

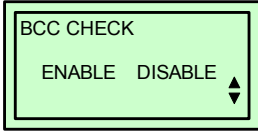
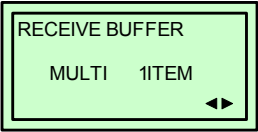
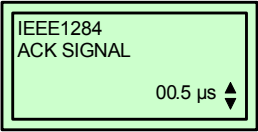
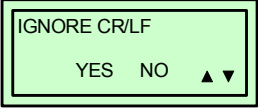
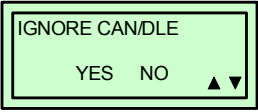
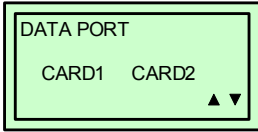
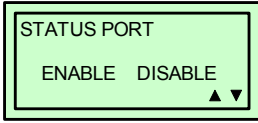
INTERFACE MODES (4-4 THROUGH 4-8)	
MENU	DESCRIPTION
	<p>Displays the operational status of the printer. The ONLINE status is displayed on the top line and the label quantity status on the bottom. The message will be changed to OFFLINE whenever the printer is switched offline by pressing the LINE key. When a print job is received, the quantity line will indicate the number of labels to be printed. As the label job prints, the display indicates the number of labels remaining to be printed.</p>
	<p>Displays the operational status of the printer. The OFFLINE status is displayed on the top line and the label quantity status on the bottom. The message will be changed to ONLINE whenever the printer is switched online by pressing the LINE key.</p>
	<p>Is the premiere screen of the Interface Mode. Interface Mode allows the parameters to be set for the printer to communicate with a host and vice-versa.</p>
	<p>Select yes if an interface card for bi-directional communication will be configured.</p>
	<p>This menu allows the identification of which installed interface card is used for bi-directional communication/printing. The remaining card, by default, is assigned to the mini-LAN card for transmitting printer status information to a LAN.</p> <ul style="list-style-type: none"> • CARD 1: Normal interface card. • CARD 2: Mini-LAN
	
	<p>Allows item number check to be enabled or disabled. Will only appear when Status5 is set for protocol.</p>

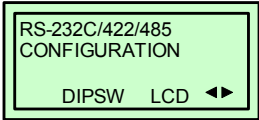
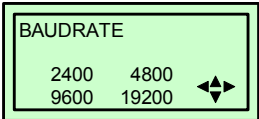
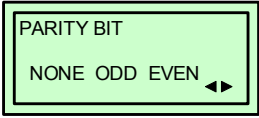
INTERFACE MODES (4-4 THROUGH 4-8)	
MENU	DESCRIPTION
	Allows BCC check to be enabled or disabled. Will only appear when Status5 is set for protocol.
	Allows selection of the receive buffer type. Select MULTI for multiple buffer and 1ITEM for a single item buffer. Will only appear if RS232C, RS422/485, IEEE1284, or Centronics interface is installed unless the card is set for RS232C, RS422/485, or Centronics is set for protocol.
	Allows setting for ACK width of IEEE1284 interface. Display will appear when the IEEE1284 interface is present and one item is selected as a receive buffer.
	<p>Determines whether the print data code requires deletion. Hexadecimal graphic data will not be deleted. Select YES to delete all carriage return (CR) and line feed (LF) commands in the data stream including graphics and 2D bar codes.</p> <p>This feature is used primarily to maintain compatibility with earlier models of SATO printers.</p>
	Allows 1 byte command such as CAN and DLE code to be deleted. Will only appear when the communication protocol is STATUS4 (for overseas precifications).
	Allows select of the port to receive print data. CARD1 will receive data sent from the existing interface and CARD2 will receive print data from the Mini LAN. When print data is received from a port different from the specified setting, the data will be deleted.
	Use this setting to enable or disable the status return port. The interface card which is not being used as the data input port is the status return port. This selection should be relative to the setting of the prior menu.

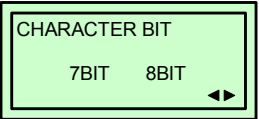
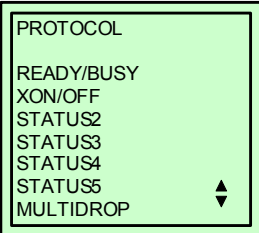
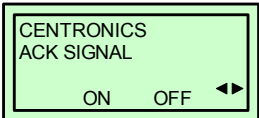

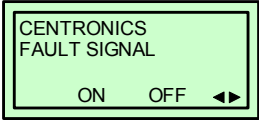
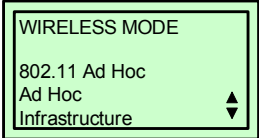
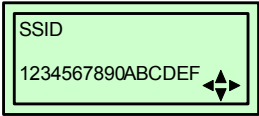
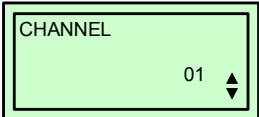
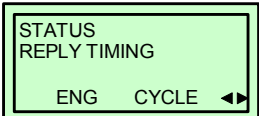
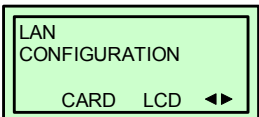
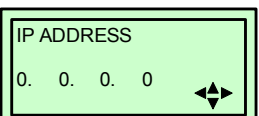
INTERFACE MODES (4-4 THROUGH 4-8)	
MENU	DESCRIPTION
	Allows determination of which method of configuration has priority; the relative dip switch or the LCD menu. This screen is displayed only when the applicable interface card is installed.
	Allows selection of the baud rate. Will only appear when the RS232C interface is installed and the LCD option is chosen from the prior menu.
	Allows setting of the Parity Bit for the RS232C interface. Will not display if the dip switch priority option is chosen. The interface card must be installed.
	Allows Stop Bit selection for the RS232C interface. Will not display if the dip switch priority option is chosen.
	Allows selection of the data length for the RS232C interface. Will not display if the dip switch priority option is chosen.
	Allows setting of communication protocol. Will only appear if RS232C or RS422/485 interface is installed (except if the relative dip switch is set with either as the priority).
	Allows setting for output timing of ACK signal for Centronics interface. Select ON for output outside the busy signal and OFF for inside the busy signal. Will only display if the Centronics interface is installed.

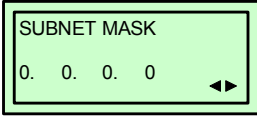
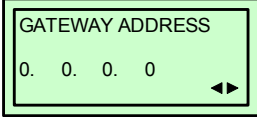
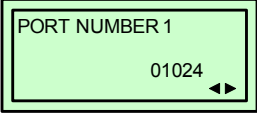
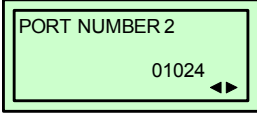
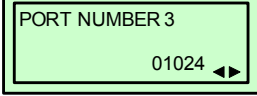
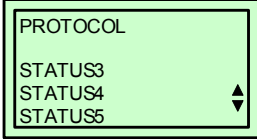
INTERFACE MODES (4-4 THROUGH 4-8)	
MENU	DESCRIPTION
	<p>Allows setting for output timing of fault signal for Centronics interface. Select ON for synchronous output with Select signal and OFF with asynchronous outputs with Select signal. Will only display if the Centronics interface is installed.</p>
	<p>Allows the selection of the desired communication mode. Will only appear if mini-LAN interface is present. Will not appear if Card is selected as the priority. Will become active upon power reboot.</p>
	<p>This display allows setting for SSID of wireless LAN. English (uppercase/lowercase) and number can be entered up to 32 digits. This display will only appear if wireless LAN is installed. Will not appear if Card is selected as the priority. Will become active upon power reboot.</p>
	<p>This menu allows channel selection for wireless LAN. This display will only appear if wireless LAN is installed. Will not appear if Card is selected as the priority. Will become active upon power reboot.</p>
	<p>Allows selection of the timing of returning status data to the host. ENQ will return the data on status after receiving a status request (ENQ) from the host. CYCLE will return a status from the printer to the host at intervals of 500ms. Will only appear when LAN or wireless LAN is present and if selecting Status 4 for communication protocol.</p>
	<p>Allows determination of whether the interface card or the LCD will take priority precedence. Will become active upon power reboot.</p>
	<p>Allows setting of the IP address. This display will not appear if any LAN interface is present or Card is not selected in the prior menu. Will become active upon power reboot.</p>

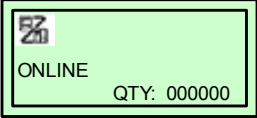
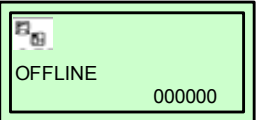
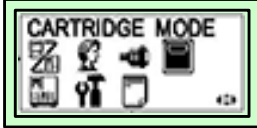
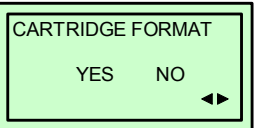
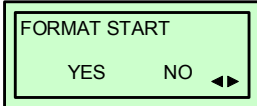
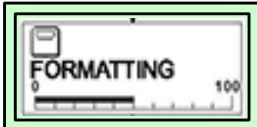
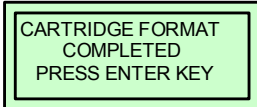

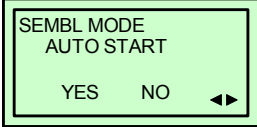
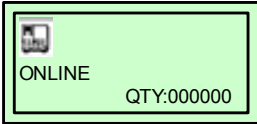
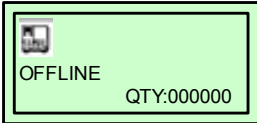
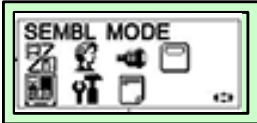
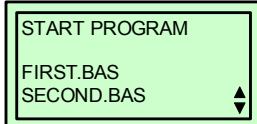
INTERFACE MODES (4-4 THROUGH 4-8)	
MENU	DESCRIPTION
	Allows setting of the subnet mask. This display will only appear if any LAN interface is present and the Card option is not selected in the prior menu. Will become active upon power reboot.
	Allows setting of the gateway address. Will only appear if any LAN interface is present. Will not appear if Card is selected as the priority. Will become active upon power reboot.
	Allows configuration of port number 1 for LAN. Will only appear if mini-LAN interface is present. Will not appear if Card is selected as the priority. Will become active upon power reboot. Values already in use for ports 2 and 3 cannot be reassigned.
	Allows configuration of port number 1 for LAN. Will only appear if mini-LAN interface is present. Will not appear if Card is selected as the priority. Will become active upon power reboot. Values already in use for ports 1 and 3 cannot be reassigned.
	Allows configuration of port number 1 for LAN. Will only appear if mini-LAN interface is present. Will not appear if Card is selected as the priority. Will become active upon power reboot. Values already in use for ports 1 and 2 cannot be reassigned.
	<p>Allows setting of communication protocol.</p> <p>STATUS 3: Will only appear if RS232C, RS422/485, LAN, or Wireless LAN interface is installed (except if the relative dip switch is set with the RS interfaces as the priority).</p> <p>STATUS 4: Will only appear if RS232C, RS422/485, LAN/ Wireless LAN, IEEE1284, or USB interface is installed (except if the relative dip switch is set with the RS interfaces as the priority).</p> <p>STATUS 5: Will only appear if RS232C, LAN/Wireless LAN, IEEE1284, or USB interface is installed (except if the relative dip switch is set with the RS interfaces as the priority).</p>

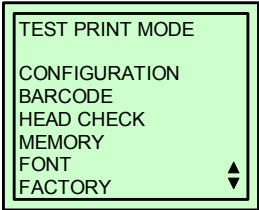
CARTRIDGE MODE (4-9)	
MENU	DESCRIPTION
	<p>Displays the operational status of the printer. The ONLINE status is displayed on the top line and the label quantity status on the bottom. The message will be changed to OFFLINE whenever the printer is switched offline by pressing the LINE key. When a print job is received, the quantity line will indicate the number of labels to be printed. As the label job prints, the display indicates the number of labels remaining to be printed.</p>
	<p>Displays the operational status of the printer. The OFFLINE status is displayed on the top line and the label quantity status on the bottom. The message will be changed to ONLINE whenever the printer is switched online by pressing the LINE key.</p>
	<p>Is the premiere screen of the Cartridge Mode. SEMBL (SATO Embedded Basic Language) allows software programs written in standard Basic language to be loaded into the printer and executed without additional computer connections.</p> <p>Use the keys of the printer's operator panel to select and enter the required options.</p>
	<p>Clears the memory cartridge of all of its contents.</p>
	<p>If yes was selected at the CARTRIDGE FORMAT screen, this display allows the initialization process to start or be cancelled.</p>
	<p>If YES was selected on the FORMAT START screen, formatting progress may be monitored here. No entry is required at this screen.</p> <p>Press CANCEL to abort formatting.</p>
	<p>Appears when formatting is complete.</p> <p>Press ENTER to return to the Normal Mode.</p>

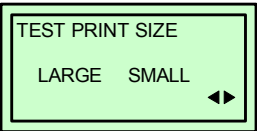
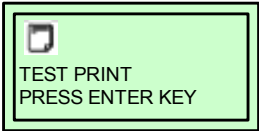
SEMBL MODE (4-10)	
MENU	DESCRIPTION
 <p>SEMBL MODE AUTO START YES NO ◀▶</p>	<p>Displays the operational status of the printer. Also displays the remaining quantity to be printed.</p>
 <p>ONLINE QTY:000000</p>	<p>Displays the operational status of the printer. The ONLINE status is displayed on the top line and the label quantity status on the bottom. The message will be changed to OFFLINE whenever the printer is switched offline by pressing the LINE key. When a print job is received, the quantity line will indicate the number of labels to be printed. As the label job prints, the display indicates the number of labels remaining to be printed.</p>
 <p>OFFLINE QTY:000000</p>	<p>Displays the operational status of the printer. The OFFLINE status is displayed on the top line and the label quantity status on the bottom. The message will be changed to ONLINE whenever the printer is switched online by pressing the LINE key.</p>
 <p>SEMBL MODE</p>	<p>Is the premiere screen of the SEMBL Mode. SEMBL (SATO Embedded Basic Language) allows software programs written in standard Basic language to be loaded into the printer and executed without additional computer connections.</p> <p>Use the keys of the printer's operator panel to select and enter the required options.</p>
 <p>START PROGRAM FIRST.BAS SECOND.BAS ▲▼</p>	<p>Permits the selection of the software program stored in the printer's memory that will be executed and used when the SEMBL Mode is started.</p>

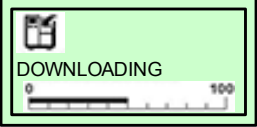
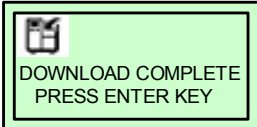
TEST PRINT MODE (4-11)	
MENU	DESCRIPTION
	<p>Is the premiere screen of the test print mode. To view this screen and access this mode, press and hold the FEED key while powering on the printer.</p> <ul style="list-style-type: none"> • Configuration: The printer's configuration setting. • Barcode: The printer's installed barcodes. • Head Check: A pattern to check print head elements. • Memory: The contents of the memory cartridge. • Font: The contents of the installed fonts. • Factory: A factory test label will be printed.
	<p>This screen only appears if Configuration, Barcode, or Head Check was chosen in the previous menu. The increments of measurement are 1cm.</p>
	<p>For factory test prints, this screen appears instead of the previous screen for setting print size. Large (10cm) and small (4cm) print sizes are the only two options.</p>
	<p>Pressing ENTER will initiate continuous test printing. Pressing ENTER again will suspend printing.</p>

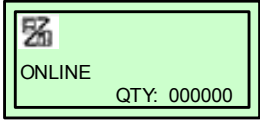
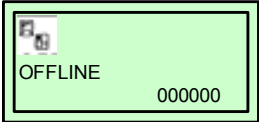
DOWNLOAD MODE (4-12)	
MENU	DESCRIPTION
	<p>Displays Confirms the printer is on stand-by for receiving download data. The doenloaded data received from the host shall be written in the memory cartridge or the main ROM. No entry is required.</p>
	<p>Downloading progress may be monitored here. No entry is required at this screen.</p> <p>Press CANCEL to abort downloading.</p>
	<p>Displays when the download process is complete. Press ENTER to exit.</p>

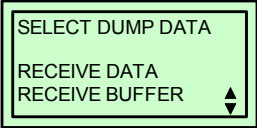
HEX DUMP MODE (4-13)	
MENU	DESCRIPTION
	<p>Displays the operational status of the printer. The ONLINE status is displayed on the top line and the label quantity status on the bottom. The message will be changed to OFFLINE whenever the printer is switched offline by pressing the LINE key. When a print job is received, the quantity line will indicate the number of labels to be printed. As the label job prints, the display indicates the number of labels remaining to be printed.</p>
	<p>Displays the operational status of the printer. The OFFLINE status is displayed on the top line and the label quantity status on the bottom. The message will be changed to ONLINE whenever the printer is switched online by pressing the LINE key.</p>
	<p>Is the premiere screen to the Hex Dump Mode. The contents of the print buffer and the data received before it is placed into the print buffer may be examined through the use of the Hex Dump Mode. Each line of the printed data is inumerated in the first column, the second column contains the data in hexadeicimal format, and the right column contains the same data in ASCII format.</p>
	<p>Only one type of data will be printed at a time. This screen allows the seletion of the data to be printed. Repeat the hex dump process to print the other type of data if required.</p>

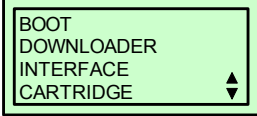
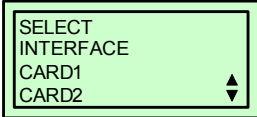
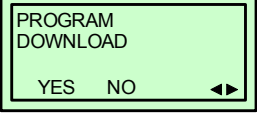
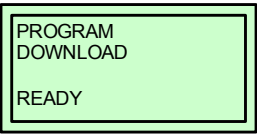
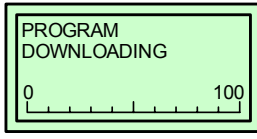
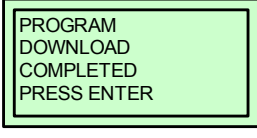
BOOT DOWNLOAD MODE (4-14)	
MENU	DESCRIPTION
	Allows selection of the download method.
	Displays the port that receives the download data. <ul style="list-style-type: none"> • Interface: Receiving data from extended interface. • Cartridge: Receiving data from Mini-LAN.
	Allows confirmation of download.
	Displays the printer is stand-by waiting for download.
	Displays download progress. Data entry is not required.
	Confirms successful execution.

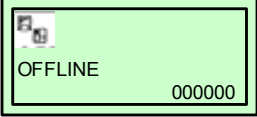
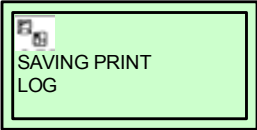
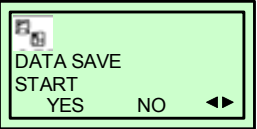
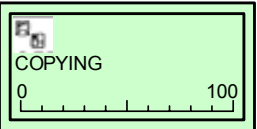
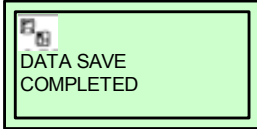
DATA SAVE MODE (4-15)	
MENU	DESCRIPTION
 <p>OFFLINE 000000</p>	<p>Displays the operational status of the printer. The OFFLINE status is displayed on the top line and the label quantity status on the bottom. The message will be changed to ONLINE whenever the printer is switched online by pressing the LINE key.</p>
 <p>SAVING PRINT LOG</p>	
 <p>DATA SAVE START YES NO ◀▶</p>	<p>Initiates receive data save activity to the memory card.</p>
 <p>COPYING 0 100</p>	<p>Displays status of receive buffer being saved to memory cartridge.</p>
 <p>DATA SAVE COMPLETED</p>	<p>Confirms completion of receive data save.</p>

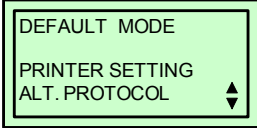
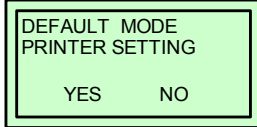
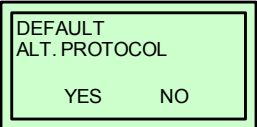
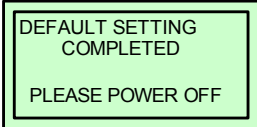
DEFAULT SETTINGS MODE (4-16)	
MENU	DESCRIPTION
	Allows selection of data to be initialized.
	Confirms selection.
	Confirms the initialization of protocol code.
	Confirms the completion of printer setup and protocol codes.

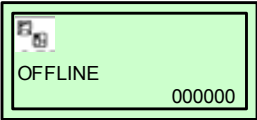
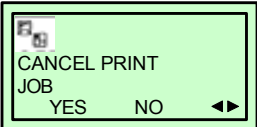
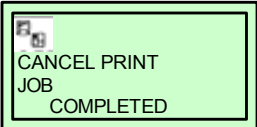
PRINT CANCEL MODE (4-17)	
MENU	DESCRIPTION
 <p>OFFLINE 000000</p>	<p>Displays the operational status of the printer. The OFFLINE status is displayed on the top line and the label quantity status on the bottom. The message will be changed to ONLINE whenever the printer is switched online by pressing the LINE key.</p>
 <p>CANCEL PRINT JOB YES NO ◀▶</p>	<p>Print data that has previously been received, can be cleared. If YES is selected, the print data will be deleted and then the printer will go offline. If the NO option is selected, the printer will go offline without deleting data.</p>
 <p>CANCEL PRINT JOB COMPLETED</p>	<p>This screen indicates that the received data has been deleted. Will display for 3 seconds and then the printer will go offline.</p>

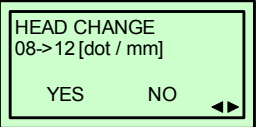
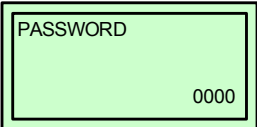
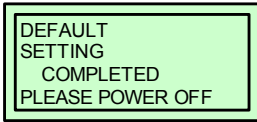
PRINT DENSITY DEFAULT MODE (4-18)	
MENU	DESCRIPTION
 <p>HEAD CHANGE 08->12 [dot / mm] YES NO ▶◀</p>	<p>Confirms the print head density or appears when switching from a print head with one density to another.</p>
 <p>PASSWORD 0000</p>	<p>Allows the entry of a password to gain access. Will only display if the SET PASSWORD display of the Service Mode is turned on.</p>
 <p>DEFAULT SETTING COMPLETED PLEASE POWER OFF</p>	<p>Confirms completion.</p>

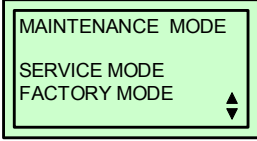
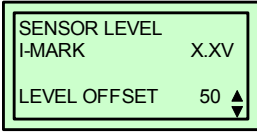
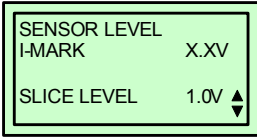
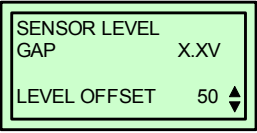
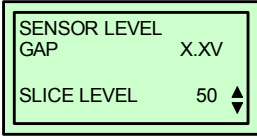
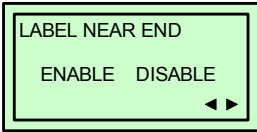

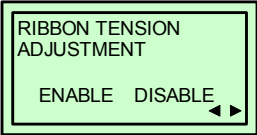
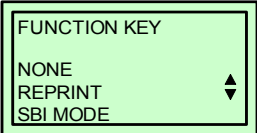
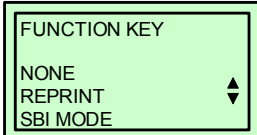
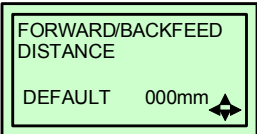
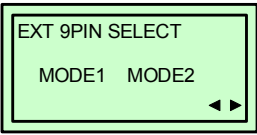
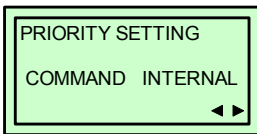
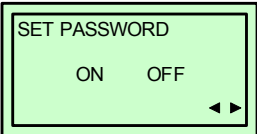
SERVICE MODE (4-19)	
MENU	DESCRIPTION
	<p>The Maintenance Mode is divided into two sections; the Service Mode and the Factory Mode.</p> <p>The Service Mode allows the programming of various dimensional settings, sensor thresholds, and language options.</p> <p>The Factory Mode permits counter reset of various printer components. Use the keys of the printer's operator panel to select and reset those features.</p>
	Allows sensitivity adjustment of the eye-mark sensor.
	Allows slice level adjustment of the eye-mark sensor.
	Allows penetrating sensor adjustment of the gap sensor.
	Allows slice level adjustment of the gap sensor.
	Select the ENABLE option to set the printer to automatically notify when media is nearly exhausted.

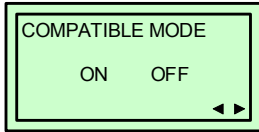
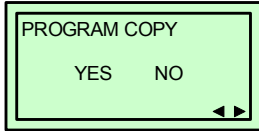
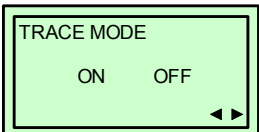
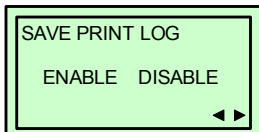
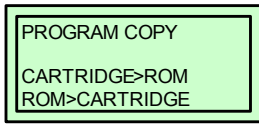
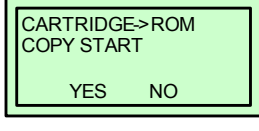
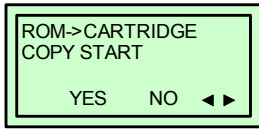
SERVICE MODE (4-19)	
MENU	DESCRIPTION
	To enable or disable the control of ribbon rewind speed.
	When enabled, the printer will monitor ribbon usage and notify when the loaded ribbon is low.
	Allows the setting of a function key.
	Allows the backfeed distance to be set. If using thermal transfer for printing, set the feed distance less than 30mm to avoid detection of ribbon end by accident.
	Allows selection output mode options. Mode 1 outputs signal in the status of existence/non-existence for the number of remaining labels to be printed. Mode 2 outputs signal in the status of online/offline.
	Displays the validity/invalidity of command data for print darkness, print speed, start point correction, operation mode, print method, and sensor types.
	Allows the password function to be enabled and disabled.

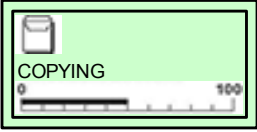
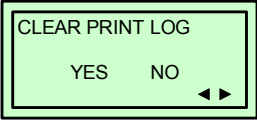
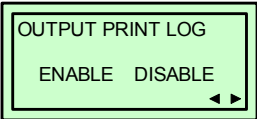
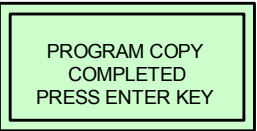
SERVICE MODE (4-19)	
MENU	DESCRIPTION
	Determines whether or not the printer will be compatible with a previous printer.
	Allows copying of firmware data.
	Enables the display of an operating log as an icon in Normal Mode. The three types are DataReceived, DataEdit, and Print. Each icon will be over-written and cleared when going to Online Mode.
	Allows the print log to be saved in the memory cartridge. The cartridge must be installed to function.
	Allows select of where firmware data will be copied.
	Initiates the copying process.
	Initiates the copying process.

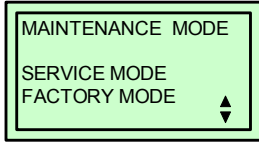
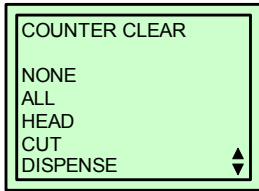
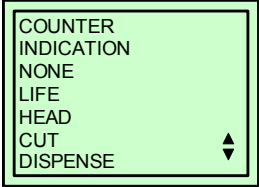
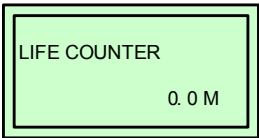
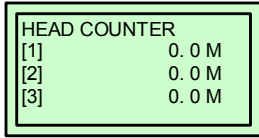
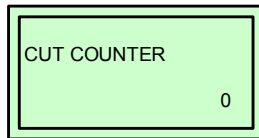
SERVICE MODE (4-19)	
MENU	DESCRIPTION
	Confirms copying is in progress. Data entry not required.
	Enables the print log to be deleted from the memory cartridge.
	Enables the print log to be sent to the status port in real-time.
	Confirms the program has been copied.

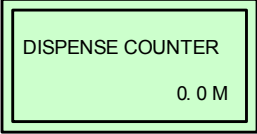
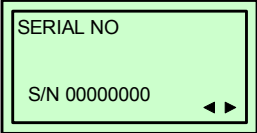
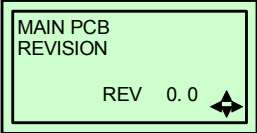
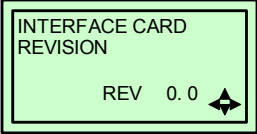
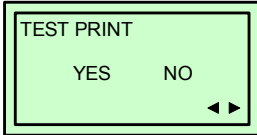
FACTORY MODE (4-20)	
MENU	DESCRIPTION
	<p>The Maintenance Mode is divided into two sections; the Service Mode and the Factory Mode.</p> <p>The Service Mode allows the programming of various dimensional settings, sensor thresholds, and language options.</p> <p>The Factory Mode permits counter reset of various printer components. Use the keys of the printer's operator panel to select and reset those features.</p>
	<p>Enables the printer's internal counter to be initiated and reset . The counter options are : None, All, Head, Cut, and Dispense.</p>
	<p>Allows view of cycles recorded by the printer's internal counter.</p>
	<p>Enables view of the printer's internal life counter.</p>
	<p>Displays values for the head counter.</p>
	<p>Displays values for the cutter counter.</p>

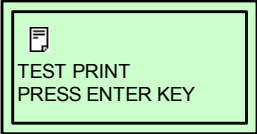
FACTORY MODE (4-20)	
MENU	DESCRIPTION
 <p>DISPENSE COUNTER 0.0 M</p>	Displays values for the dispenser counter.
 <p>SERIAL NO S/N 00000000</p>	Enables the printer's serial number to be recorded within the printer.
 <p>MAIN PCB REVISION REV 0.0</p>	Enables the revision number of the main circuit board to be recorded.
 <p>INTERFACE CARD REVISION REV 0.0</p>	Enables the revision number of the interface card to be recorded.
 <p>TEST PRINT YES NO</p>	Initiates test printing.
 <p>PRINT SIZE SMALL LARGE</p>	Enables the print size to be selected.
 <p>TEST PRINT PRESS ENTER KEY</p>	Confirms factory test printing is underway.

OPERATIONAL ADJUSTMENTS

These operational adjustments are for fine tuning the printer as necessary following the configuration process and are largely confined to the four potentiometers located on the operator panel. Refer to the table below for their function.

POTENTIOMETER	DESCRIPTION/PROCEDURE
VOLUME	Adjusts the audible decimal level for error indication. Power on the printer, place on-line, and open the print head. When the beep is emitted, adjust the volume level accordingly.
PITCH	<p>Is to be used in conjunction with the configuration adjustments. Make course adjustments there and then fine tune here. If unable to achieve the desired setting here, the course adjustment must be reset. Adjust this potentiometer as labels are being printed. Allow two labels to be printed for each adjustment to ensure a desired setting.</p> <p>Adjustment of the PITCH potentiometer will affect the print offset position. Thusly, if using a dispenser or cutter, adjust the Offset first and then the Pitch.</p>
OFFSET	<p>The offset adjustment is used to reposition the media for printing following advancement for dispensing or cutting. A label is printed, it is fed forward for dispense, the printer retracts the remaining media (offset) to print the next label. To preform this adjustment:</p> <ol style="list-style-type: none"> 1. Power On the printer. 2. Press the LINE key to place printer offline. 3. Advance to the User Mode and press ENTER. 4. Adjust the OFFSET potentiometer. 5. Press the FEED key to feed another label. 6. Repeat steps 3 and 4 until properly adjusted. 7. Press the LINE key to bring the printer back online.
DARKNESS	<p>Is used to adjust the darkness or lightness of the printed image and should be used in conjunction with the configuration adjustments. Make course adjustments there and then fine tune here. If unable to achieve the desired setting here, the course adjustment must be reset.</p> <p>Adjust this potentiometer as labels are being printed. Allow two labels to be printed for each adjustment to ensure a desired setting.</p>

NOTE: The two Figures that follow are provided to identify reference positions to assist in the operational adjustment process.

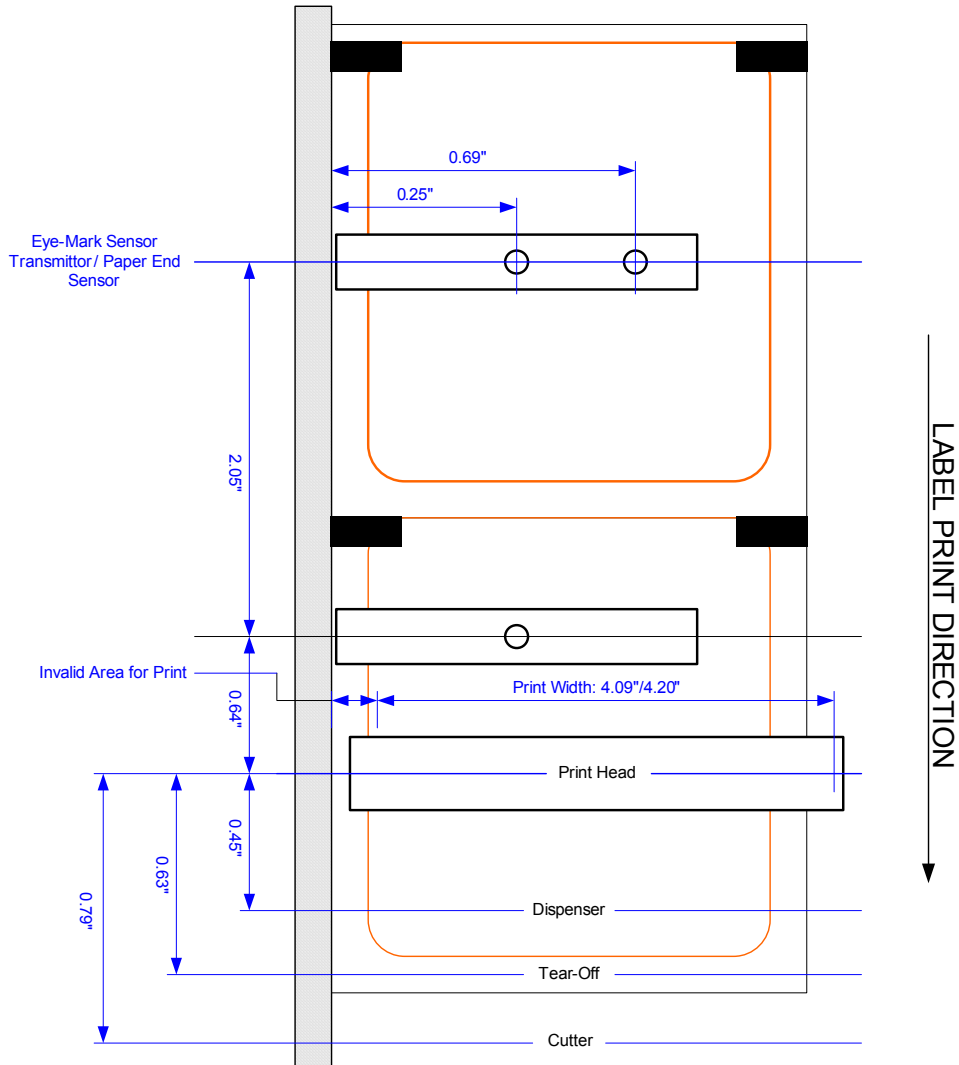

Figure 4-21, Sensor & Accessory Positioning

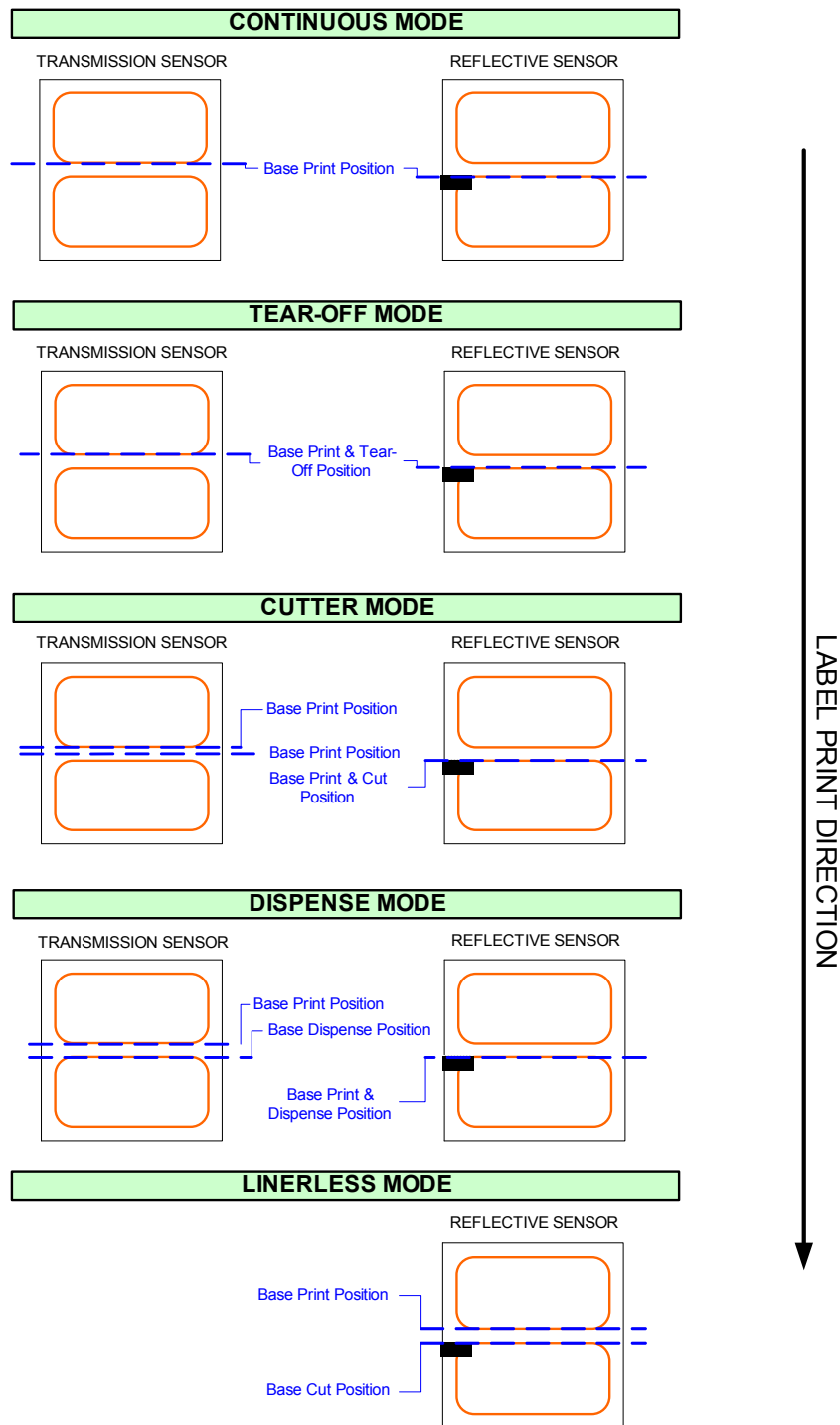
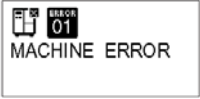

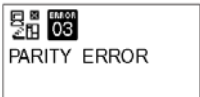
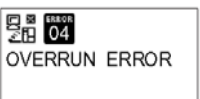
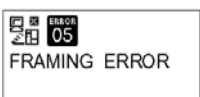





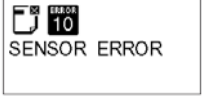

Figure 4-22, Print Base Reference Position





5



TROUBLESHOOTING



- **Error Signals**
- **Troubleshooting Table**
- **Interface Troubleshooting**
- **Test Print Troubleshooting**
- **Sensor Locations**

ERROR SIGNALS		
Error No.	LCD Display	Description
01		Machine Error
		Cause: Circuit board problem. Remedy: Contact a sales outlet, dealer, or service center. Alarm sound: One long beep. External signal: Machine error.
02		Flash ROM Error
		Cause(s): 1. Flash ROM cannot be accessed. 2. Illegal firmware operation requested by software. Remedy: Contact a sales outlet, dealer, or service center. Alarm sound: One long beep. External signal: Machine error.
03		Parity Error
		Cause(s): 1. RS-232C communication settings fail parity check. 2. Error in cable connection. Remedy: Ensure correct communication cables and settings. Alarm sound: Three short beeps. External signal: Machine error.
04		Overrun Error
		Cause(s): 1. RS-232C communication settings exceed legal values. 2. Error in cable connection. Remedy: Check and correct communication cables and settings. Alarm sound: Three short beeps. External signal: Machine error.
05		Framing Error
		Cause(s): 1. Incorrect frame size for the RS-232C settings. 2. Cable connection trouble. Remedy: Check and correct communication cables and settings. Alarm sound: Three short beeps. External signal: Machine error.
06		Buffer Overflow error
		Cause(s): 1. Size of received data exceeds size of receiving buffer. 2. Mismatched send/receive communication protocols. Remedy: Establish the correct communication protocol. Alarm sound: Three short beeps External signal: Machine error

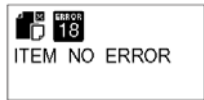
ERROR SIGNALS		
Error No.	LCD Display	Description
07		Head Open error
		<p>Cause(s): 1. The head unit is not properly latched. 2. Malfunctioning head-open switch.</p> <p>Remedy: Properly latch the print head and/or replace the switch.</p> <p>Alarm sound: Three short beeps.</p> <p>External signal: Machine error.</p>
08		Paper End error
		<p>Cause(s): 1. The media supply has run out. 2. The media is not set correctly.</p> <p>Remedy: Set the media correctly.</p> <p>Alarm sound: Three short beeps.</p> <p>External signal: Paper end.</p>
09		Ribbon End error
		<p>Cause(s): 1. The ribbon supply has run out. 2. The ribbon has been damaged.</p> <p>Remedy: 1. Set the ribbon correctly. 2. Clean the ribbon path.</p> <p>Alarm sound: Three short beeps.</p> <p>External signal: Ribbon end.</p>
10		Sensor error
		<p>Cause(s): 1. Incorrectly adjusted paper sensor. 2. Incorrectly selected media sensor. 3. Erratic paper flow.</p> <p>Remedy: 1. Adjust sensitivity of paper sensor. 2. Select correct sensor type for media being used. 3. Clean the paper path to establish a smooth paper flow.</p> <p>Alarm sound: Three short beeps</p> <p>External signal: Machine error</p>
11		Head related error
		<p>Cause: There is a problem with the print head.</p> <p>Remedy: Clean and/or replace print head.</p> <p>Alarm sound: One long beep.</p> <p>External signal: Machine error.</p>

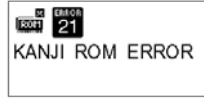
ERROR SIGNALS		
Error No.	LCD Display	Description
12		Memory Writing error
		<p>Cause(s):</p> <ol style="list-style-type: none"> 1. Memory cartridge is not inserted. 2. Memory space is exhausted. 3. Read/Write operation has failed. 4. Memory is not properly formatted. <p>Remedy:</p> <ol style="list-style-type: none"> 1. Ensure memory cartridge is installed. 2. Ensure sufficient memory space is available. 3. Replace the memory cartridge. 4. Format or reformat the memory cartridge. <p>Alarm sound: One long beep.</p> <p>External signal: Machine error.</p>
13		Memory Reading error
		<p>Cause: Memory space is exhausted.</p> <p>Remedy: Delete unnecessary data to free up memory space.</p> <p>Alarm sound: One long beep.</p> <p>External signal: Machine error.</p>
14		Download Data Error
		<p>Cause(s):</p> <ol style="list-style-type: none"> 1. Received invalid download. 2. There is no download area. <p>Remedy:</p> <ol style="list-style-type: none"> 1. Ensure the download data is correct. 2. Ensure the download data size is correct. <p>Alarm sound: One long beep.</p> <p>External signal: Machine error.</p>
15		Cutter error
		<p>Cause(s): The cutter unit is jammed or clogged.</p> <p>Remedy:</p> <ol style="list-style-type: none"> 1. Cutter blade did not returned to the home position. Clean the cutter unit and clear any paper jams. 2. Press FEED to reinstate proper cutter blade position. <p>Alarm sound: Three short beeps.</p> <p>External signal: Machine error.</p>
16		Cutter Open error
		<p>Cause(s):</p> <ol style="list-style-type: none"> 1. The upper bracket of the cutter unit is open 2. The sensor is malfunctioning <p>Remedy: Close the upper bracket of the cutter unit.</p> <p>Alarm sound: Three short beeps</p> <p>External signal: Machine error</p>

ERROR SIGNALS		
Error No.	LCD Display	Description
17		BCC Check error
		<p>Cause: BCC attached to sending data (for an item) is different.</p> <p>Remedy: Ensure the data communication settings are correct.</p> <p>Alarm sound: Three short beeps.</p> <p>External signal: Machine error.</p>
18		Item Number error
		<p>Cause: The sequence number of present and past print data (for an item) does not match.</p> <p>Remedy: Ensure data communication settings are correct.</p> <p>Alarm sound: Three short beeps.</p> <p>External signal: Machine error.</p>
19		Winding Full error
		<p>Cause(s): 1. The label rewinder needs to be emptied 2. The sensor is malfunctioning</p> <p>Remedy: Remove the wound label.</p> <p>Alarm sound: Three short beeps</p> <p>External signal: Machine error</p>
20		Head Density error
		<p>Cause(s): 1. The print head is not correctly installed. 2. An unsupported print head is installed.</p> <p>Remedy: Ensure the print head is suitable for use with this printer and that it is properly installed.</p> <p>Alarm sound: Three short beeps.</p> <p>External signal: No output.</p>
21		Kanji ROM error
		<p>Cause: Invalid Kanji data has been read from the Kanji ROM</p> <p>Remedy: Ensure the Kanji ROM has been properly installed.</p> <p>Alarm sound: Three short beeps</p> <p>External signal: Machine error</p>

ERROR SIGNALS		
Error No.	LCD Display	Description
23		RFID Tag error Cause: Difficulties writing into RFID tag. Remedy: Write information in another RFID tag. Alarm sound: Three short beeps. External signal: Machine error.
		RFID Tag error Cause: Difficulties writing into the RFID tag. Remedy: Replace the RFID tag. Press the Line key to retry. Alarm sound: Three short beeps. External signal: Machine error.
		RFID Protect error Cause: The RFID tag is write-protected. Remedy: Replace the tag with one that is not write-protected. Alarm sound: Three short beeps. External signal: Machine error.
24		Non-Lock Error Cause: The knob of the ribbon-winding unit is not locked. Remedy: Lock the knob of the ribbon-winding unit. Alarm sound: Three short beeps. External signal: Machine error.

TROUBLESHOOTING TABLE	
IMAGE VOIDS	
Damaged print head.	Replace print head.
Damaged electronics.	Replace circuit board.
Damaged or worn platen roller.	Replace platen roller.
Vertical line in printed image.	Dirty or defective print head.
LIGHT PRINT IMAGES	
Low print head energy/darkness.	Adjust darkness control.
Low print head pressure.	Adjust head balance.
Foreign material on print head.	Clean print head and platen roller.
Poor head alignment.	Align print head as required.
Excessive print speed.	Reduce print speed setting.
UNEVEN PRINT DARKNESS	
Unbalanced print head.	Ensure correct balance.
Worn platen roller.	Replace platen roller as required.
Dirty print head.	Clean as necessary.
SMEARED PRINT IMAGES	
Poor label quality.	Use high quality label stock.
Foreign material on print head and platen roller.	Clean print head and platen roller.
Foreign material on labels.	Use high quality label stock.
Excessive print head energy.	Adjust darkness control.
Excessive print speed.	Adjust as speed as required.
Excessive head pressure.	Adjust head balance.
NO LABEL MOVEMENT	
Loose timing belt.	Ensure motor mount screws are tight, belt properly tensioned.
Incorrect label pitch sensor selected.	Select the correct label sensor type.
No voltage output.	Replace fuse on main circuit board. Test power supply and replace as required.
Drive motor not operating.	Ensure wiring harness connection. Replace as necessary.
Defective main board.	Troubleshoot board and replace as necessary.
NO PRINTED IMAGE	
Print head is disconnected.	Ensure print head wiring harness is connected on each end.

NO PRINTED IMAGE	
No voltage output.	Test power supply and replace as necessary.
Damaged print head.	Replace print head.
Damaged electronics.	Replace circuit board.
Interface problems.	Check. Refer to relative instructions below.
Data input error.	Ensure correct data stream.
LCD FIELD ILLUMINATED BUT WITHOUT WORDS OR NO DISPLAY AT ALL	
Power cable issues.	Ensure properly connected. Ensure not defective.
Incorrectly positioned display potentiometer.	Adjust as required.
Defective power supply.	Troubleshoot and replace components as necessary.
MEANDERING MEDIA	
Incorrectly loaded media.	Ensure correct loading.
Improperly adjusted media guides.	Adjust as required.
Unbalanced print head.	Adjust as required.
Worn or improperly adjusted platen roller.	Adjust. Replace as required.
PRINTER CREATES A BLANK LABEL	
Data input error.	Ensure correct data stream.
Improper media selected.	Ensure correct media is in use.
Disconnected print head.	Cycle off power and ensure proper connection.
Defective print head.	Replace print head as required.
Defective main board.	Replace main board as required.
INCORRECT LABEL POSITIONING	
Incorrect sensor selection.	Ensure the correct sensor is selected.
Improper sensor adjustment.	Adjust as required.
Incorrect media in use.	Ensure the correct media is being used.
Data input error.	Ensure correct data stream.

INTERFACE TROUBLESHOOTING

This unit provides a checklist for the various interface types. Locate the checklist relative to the interface used and perform each of the troubleshooting tasks until the problem has been isolated.

PARALLEL INTERFACE	
CHK	TROUBLESHOOTING STEP
	Ensure the interface module is correctly installed. Run self-test to verify.
	Ensure the printer cable is connected to the appropriate LPT port on the host computer. If using a Windows printer driver, ensure the correct port is selected.
	Ensure a IEEE1284 printer cable is being used.
	Ensure the host's peripheral settings are set to ECP for faster throughput. Refer to the computer manufacturer's documentation for details.
	Ensure the printer is receiving information from the computer using the Receive Buffer Hex Dump mode. Refer to that procedure within this manual for instructions. The command stream should be continuous and possess 0Dhex and/or 0Ahex (carriage return and line feed) characters throughout. However, there should not be either locate between the start (<ESC>A and the stop (<ESC>Z) commands.
	Replace the interface board with another to isolate the problem.
	Replace the interface board permanently if determined to be the problem.

RS232 SERIAL INTERFACE	
CHK	TROUBLESHOOTING STEP
	Ensure the correct interface module is correctly installed. Run self-test to verify.
	Ensure the serial cable (Null Modem) meets specifications and is correctly connected at each end.
	Ensure the serial cable is not defective.
	Ensure the communication parameters for the baud rate, parity, data bits and stop bits are consistent with those being sent from the host computer.
	Ensure the printer is receiving information from the computer using the Receive Buffer Hex Dump mode. Refer to that procedure within this manual for instructions. The command stream should be continuous and possess 0Dhex and/or 0Ahex (carriage return and line feed) characters throughout. However, there should not be either locate between the start (<ESC>A and the stop (<ESC>Z) commands.
	Replace the interface board with another to isolate the problem.
	Replace the interface board permanently if determined to be the problem.

LAN EHTERNET INTERFACE	
CHK	TROUBLESHOOTING STEP
	Ensure the interface has been correctly configured. Wait two minutes and run self-test to verify. If a test label does not print, there may be a hardware problem.
	Ensure the serial cable meets specifications and is correctly connected at each end.
	Ensure the cable and its ports are not defective.
	Ensure that a faulty print server or other protocol related scenarios are not creating a queue setup issue. Systematically perform checks and tests to isolate the cause.
	If using TCP/IP, ensure a valid IP address is specified and that all parameters are correct (subnet mask, gateway, etc.). Attempt to PING the IP address assigned to the network interface.
	Install the IPX/SPX protocol on a workstation to determine if the network device can be discovered via the MAC address. If able, configure the appropriate protocols and retest connectivity.
	Use a crossover cable to isolate the printer from the network by connecting from the interface and workstation. Verify that the parameters match on each. Test connectivity.

UNIVERSAL SERIAL BUS (USB) INTERFACE	
If nothing prints during a test print, verify the device drivers have been successively installed by performing the following:	
	Click on Start, Settings, and then Control Panel.
	Click on System within the new window.
	Click on the Device Manager tab.
	Ensure that the View Device By Type is checked.
	Scroll to SATO-USB Device and ensure that errors do not exist. Reinstall as required.
	Reboot the PC and the printer.
	Contact Microsoft technical support for further assistance as required.

TEST PRINT TROUBLESHOOTING

Chapter provides instruction on special printing to identify and resolve specific print problems.

- HEX DUMP** Allows the operator to determine if there were problems in the downloading of data.
- TEST LABEL** Allows the operator to identify specific problems regarding mechanical performance and setup.

HEX DUMP MODE

The contents of the print buffer can be examined using the Hex Dump Mode. In the left column, each line of data received is numbered. The center column provides the data in hexadecimal format. And in the right column, same data is provided in the ASC II format. Follow the flow chart provided below to perform this activity.

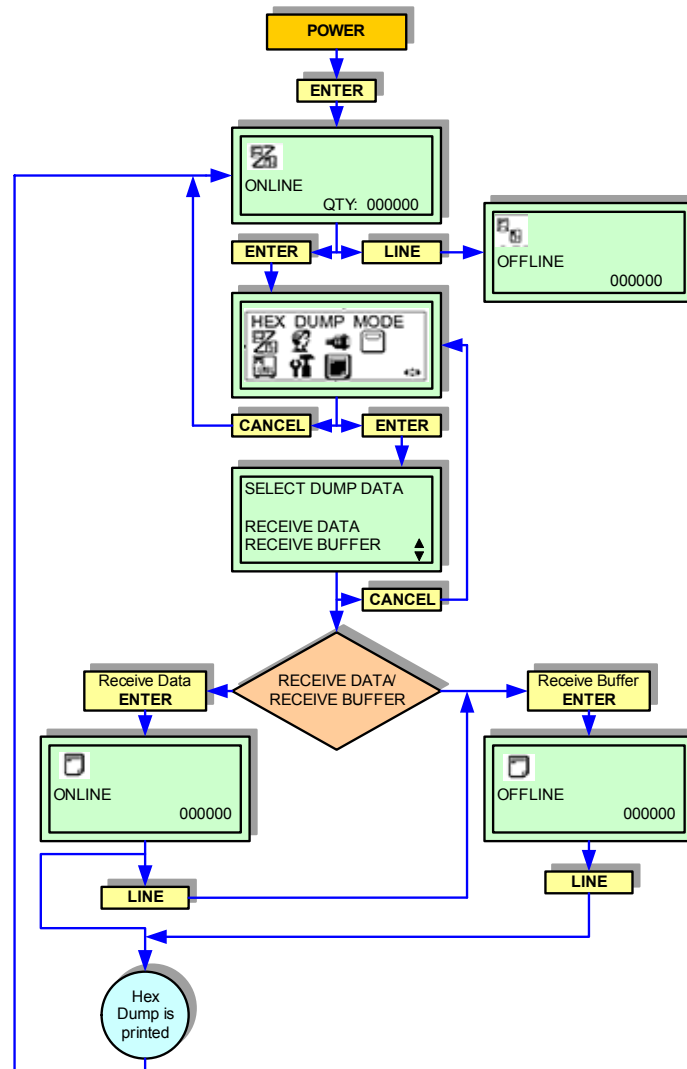

Figure 5-1, Hex Dump Mode

TEST LABEL PRINTING

The test label is designed to assist in the identification of print problems. Follow the flow chart provided below to perform this activity.

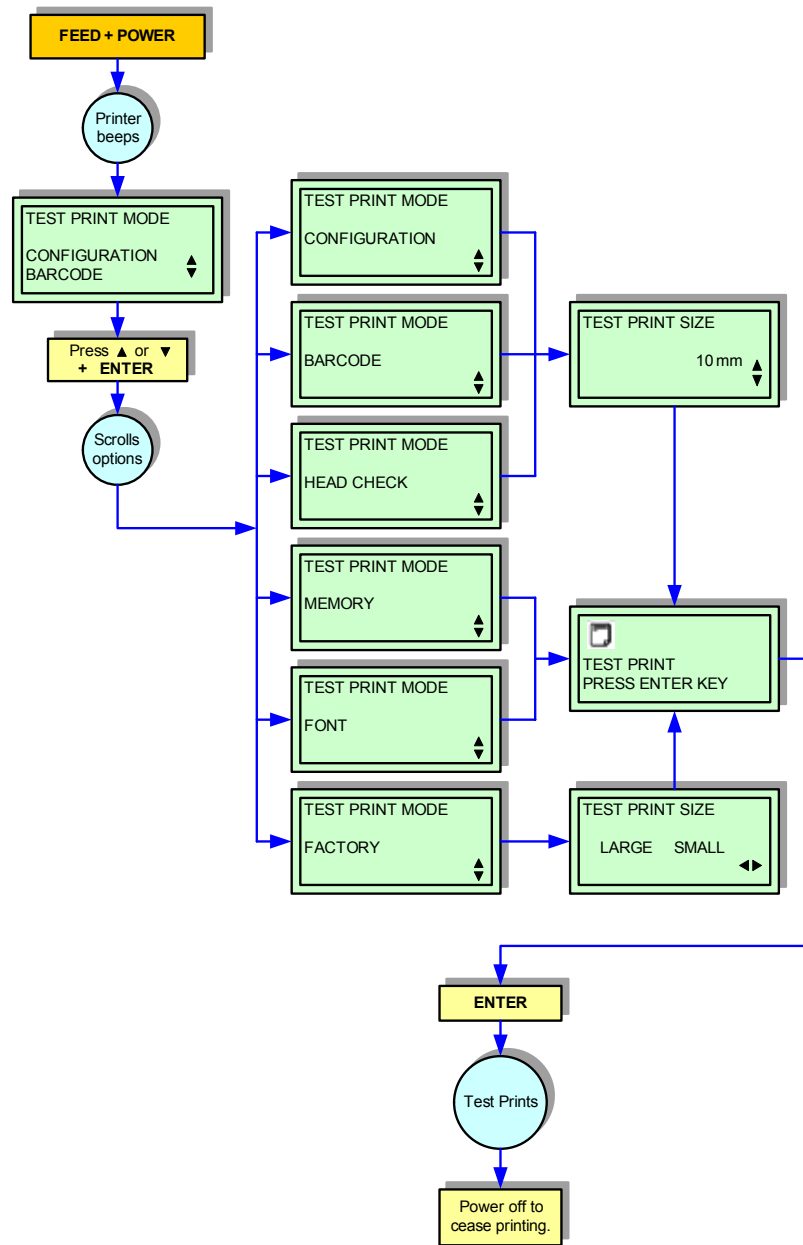

Figure 5-2, Test Print Mode

NOTE: The only print problem that the following sample test label does not display is fading of print image from one side of the label to the other. This is the result of improper print head balance.

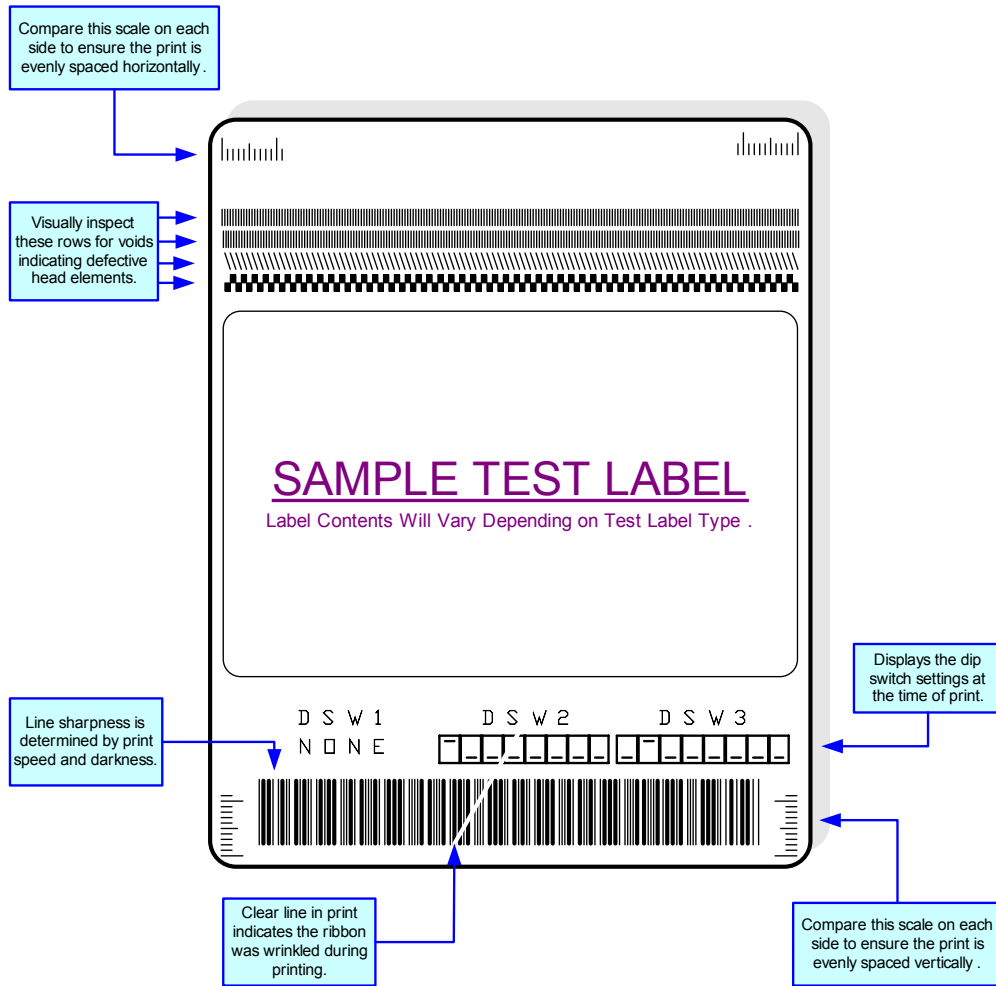

Figure 5-3, Sample Test Label

SENSOR LOCATIONS

This chapter provides a diagram identifying the locations of the printer's various sensors. Refer to the diagram provided below.

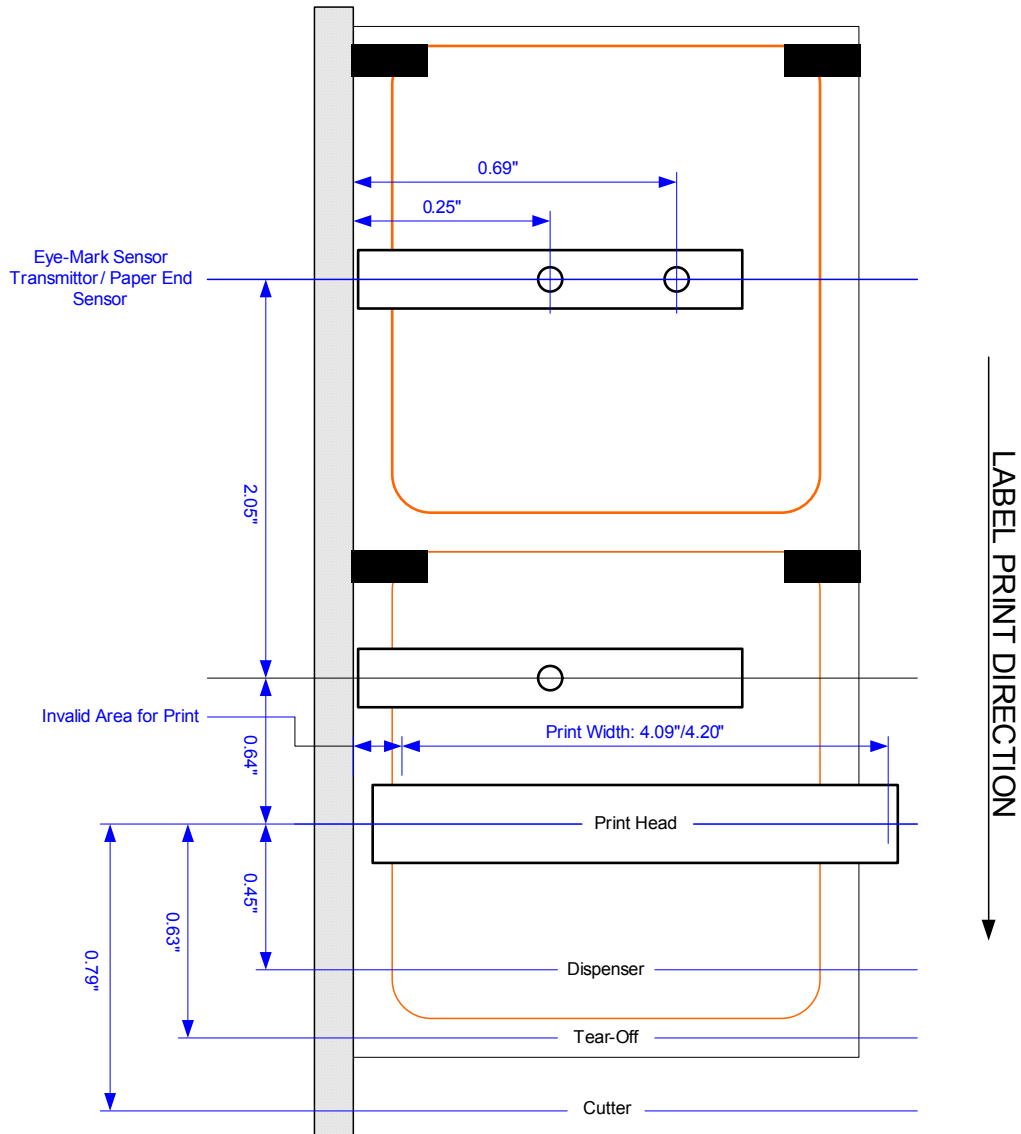

Figure 5-4, Sensor Locations

6

MAINTENANCE

- **Cleaning Procedures**
- **Replacement Procedures**
- **Adjustment Procedures**

CLEANING PROCEDURES

Cleaning of the printer is a necessary maintenance activity to ensure print quality and long printer life. There are two basic types of cleaning involved; the removal of loose debris and the removal of residue.

Use a soft cloth and/or a pneumatic blower to remove debris from the printer. This process should be performed prior to the removal of residue. To remove residue, apply SATO Solvent or isopropyl alcohol to a clean cotton swab and gently wipe the entire surface of the print head and platen roller until clean.

It is recommended that the printer be cleaned after the printing of every two rolls of labels.

WARNING: DISCONNECT POWER SUPPLY TO THE PRINTER AND ALLOW TO COOL TO ROOM TEMPERATURE PRIOR TO CLEANING.

WARNING: EXERSIZE CARE WHEN CLEANING TO PREVENT PERSONAL INJURY. THE TEAR BAR HAS A VERY SHARP EDGE.

CAUTION: IF USING A PNEUMATIC BLOWER TO REMOVE DEBRIS FROM THE PRINTER, EXERSIZE CARE TO PREVENT PRINT HEAD DAMAGE.

REPLACEMENT PROCEDURES

This unit contains step-by-step instructions for the removal and replacement of all primary components and sub-assemblies.

PRINT HEAD REPLACEMENT

If the print head becomes damaged or worn, it can be easily removed and replaced without having to make critical adjustments.

- 1 Switch off the printer and disconnect the power supply cord.
- 2 Open the top housing cover.
- 3 Press print head release lever (1, Figure 6-1) to the right.
- 4 Carefully lower and withdraw defective print head (2) from print assembly (3).
- 5 Disconnect the two wiring harnesses from defective print head (2).
- 6 Connect the two wiring harnesses to replacement print head (2, Figure 7-1b).
- 7 Insert replacement print head (2) into print assembly (3) and lift into position.

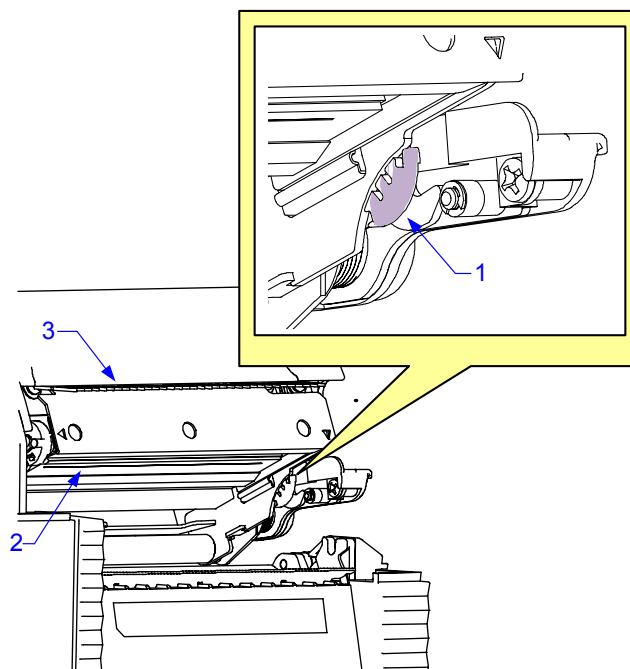

Figure 6-1a, Print Head Replacement

NOTE: Lift the left end of head bracket (4) onto shaft (5) first. Then lift the right end of head bracket (4) until it snaps into position.

- 8 Reset the head counter in accordance with the procedures enclosed.
- 9 Restore power and test print.

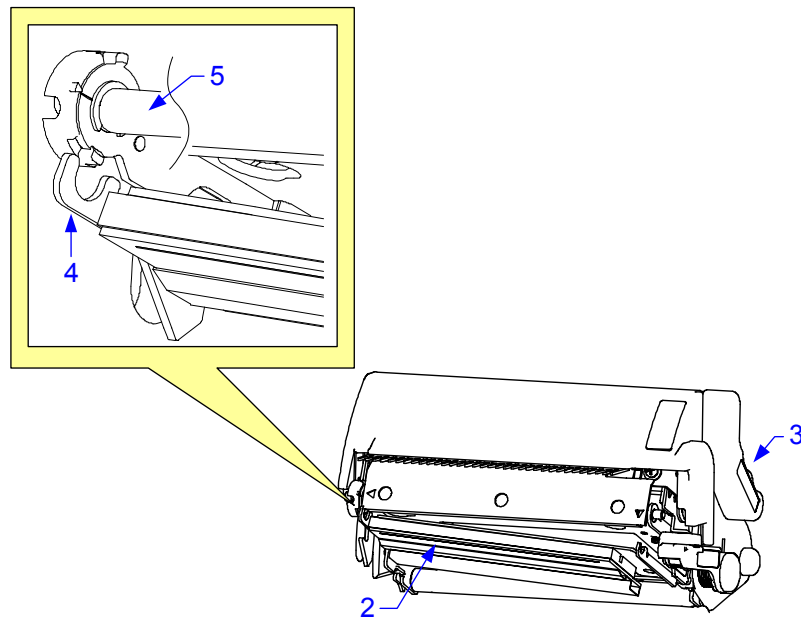

Figure 6-1b, Print Head Replacement

PLATEN ROLLER REPLACEMENT

The platen roller is considered to be a high wear component due to its treading against the print media. This treading contact will eventually wear grooves into the rubber material and negatively effect print output.

- 1 Switch off the printer, disconnect the power supply cord.
- 2 Remove the side cover and lower front housing cover.
- 3 Remove one screw (1, Figure 6-2) securing platen roller assembly (2) to printer frame (3).
- 4 Withdraw worn platen roller assembly (2) from within the printer and insert its replacement.
- 5 Secure replacement platen roller assembly (2) to printer frame (3) using one screw (1).
- 6 Reconnect power supply cord, test cycle, and reattach/close all covers.

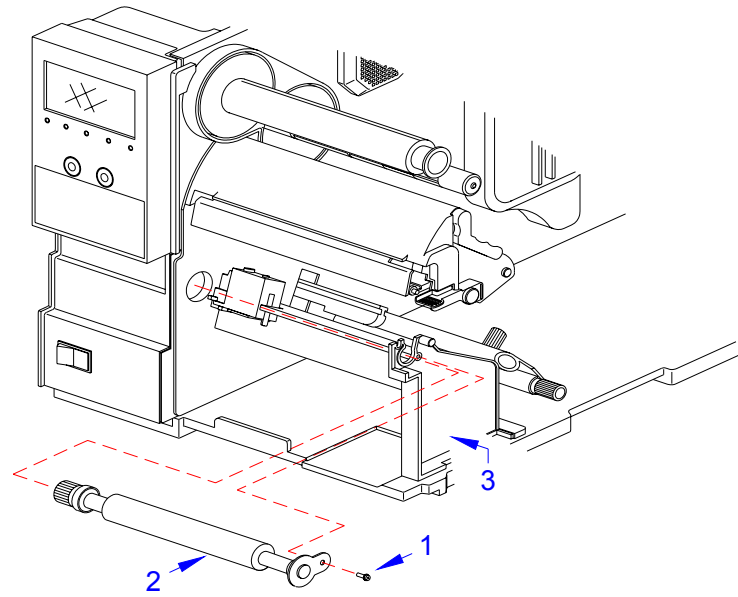

Figure 6-2, Platen Roller Replacement

ADJUSTMENT PROCEDURES

This unit covers all of the printer and printer accessory adjustments. These adjustments include mechanical adjustments required following the replacement of components and assemblies, in addition to, the operational adjustments required following a job change.

PRINT HEAD ALIGNMENT

Print head position has a direct impact on print quality. The print head must be parallel with the platen roller for the printed image to be consistent across the label.

To adjust the alignment, open the print head, turn the alignment dial, and print a test label. Repeat that process until remedy is achieved.

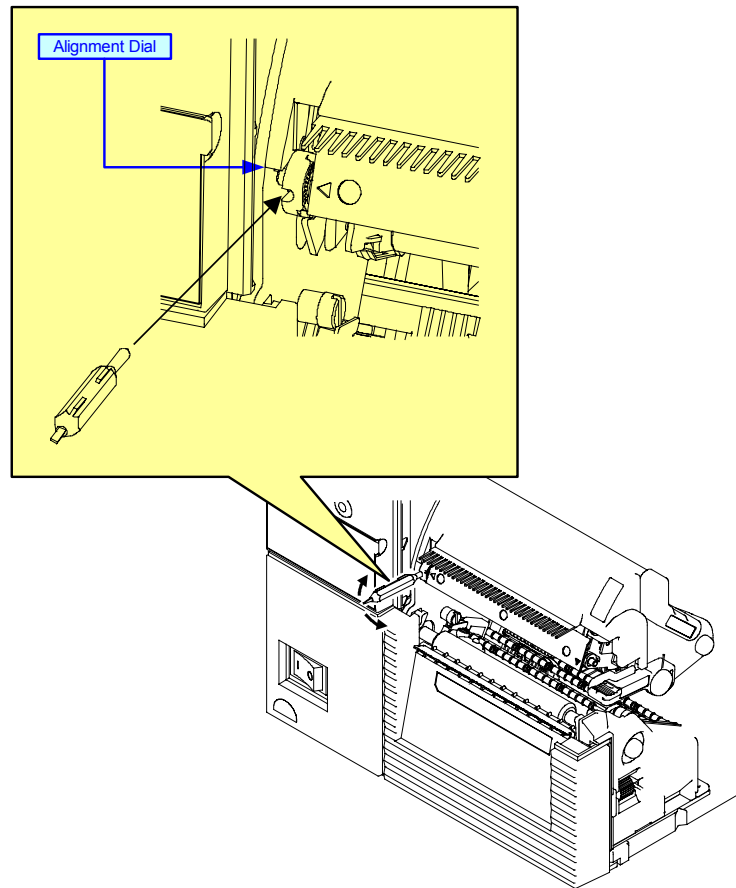

Figure 6-3, Print Head Alignment

PRINT HEAD PRESSURE ADJUSTMENT

Print head pressure adjustment allows for the print head to be adjusted to accommodate different media types (thicknesses). The pressure setting switch is two position (normal, high). The table that follows correlates the media used with a pressure setting.

PRESSURE ADJUSTMENT		
MEDIA	SCALE	THICKNESS (MM)
Thin paper, normal label, etc.	Normal	0.080-0.200
Thick paper, tag stock, etc.	High	0.200-0.268

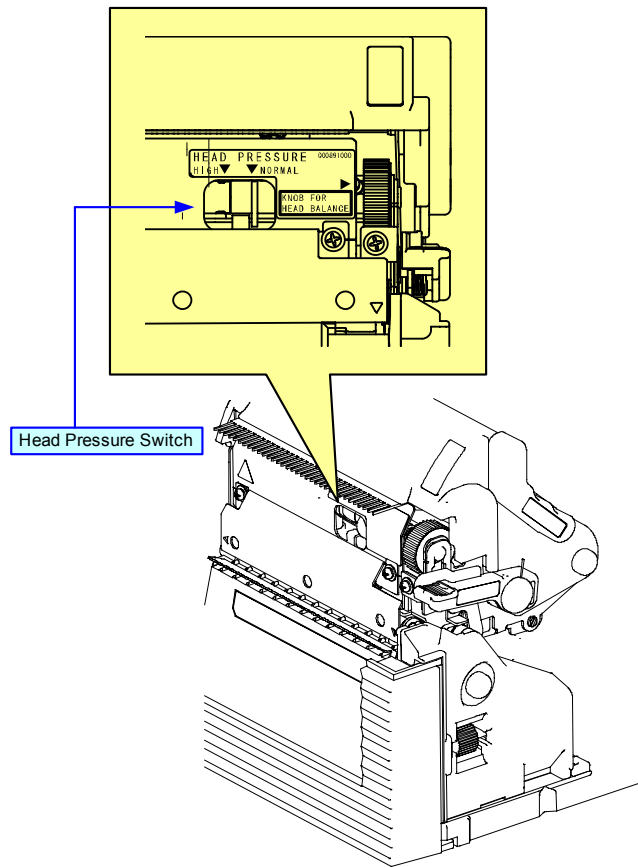

Figure 6-4, Print Head Pressure Adjustment

PRINT HEAD BALANCE ADJUSTMENT

Print head balance is the equalization of pressure against the platen roller from one end to the other. If the print head balance is out of adjustment, the printed image will be darker on side of the label than the other and the media will be prone to want to travel in the direction of least resistance.

The adjustment of print head balance on the label can be subjective. One will know when balance is achieved by the disappearance of prevailing negative characteristics. To adjust balance, a scaled dial allows adjustment based on the width of the media used. The table that follows correlates paper width with a dial setting.

BALANCE ADJUSTMENT					
Paper Width (inches)	1.00	1.68	2.35	3.11	3.75
Dial Setting	1	2	3	4	5

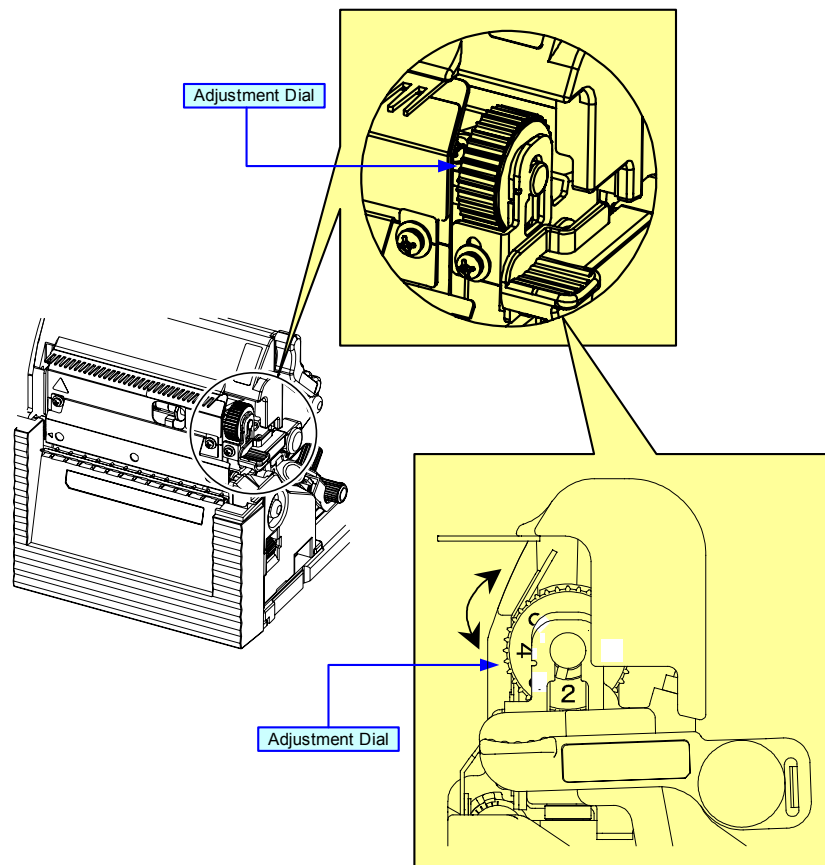

Figure 6-5, Print Head Balance Adjustment

RIBBON GUIDE ADJUSTMENT

If the print ribbon is not spread smoothly over the print head when it makes contact with the media, print voids will occur at the point of the ribbon fold. Typically, this is the result of the axis of one of the following not being perfectly parallel: ribbon spindle, ribbon roller, print head, or ribbon guide.

The purpose of the adjustable ribbon guide is to compensate for the axis deviations of the other three. By adjusting the ribbon guide proportionally to the degree of deviation, the ribbon spreads smoothly as it travels from the ribbon supply spindle, to the guide, and beyond.

Ribbon guide adjustment is a trial and error activity that requires the pause of printing, unlatching of the print head, adjusting the guide, relatching the print head, and printing once again. Several labels or tags must be printed following each adjustment to determine if the adjustment was effective.

The ribbon guide is secured to the face of the print assembly by a screw on each end. Before adjusting the guide, visually inspect that its axis is parallel with that of the print assembly. If not, adjust accordingly, ensure the set screws are secure, and once again commence printing.

By starting in a neutral position, either end may be adjusted vertically as necessary to remedy the wrinkling problem.

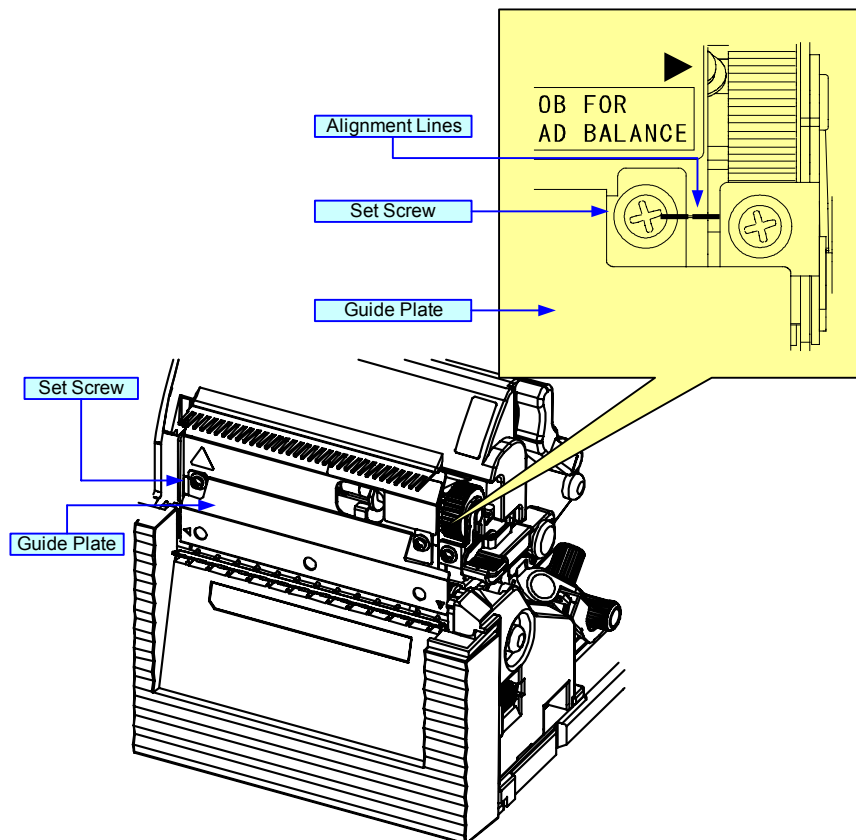

Figure 6-6, Ribbon Guide Adjustment

LABEL SENSOR POSITIONING

The label sensor assembly provides a mounting apparatus for the eye-mark, gap, and paper-end sensors. Position adjustment of the label sensor is not required when using standard label media.

When non-standard media is used, place a section of the media on the media ramp oriented as if loaded for printing. Manually grasp the sensor assembly and move it laterally so that the sensor indicators embossed in its side are aligned with the reference marks on the media.

Sensor positioning may also be achieved by measuring from the printer's center frame outward to a specified distance for sensor/reference mark alignment.

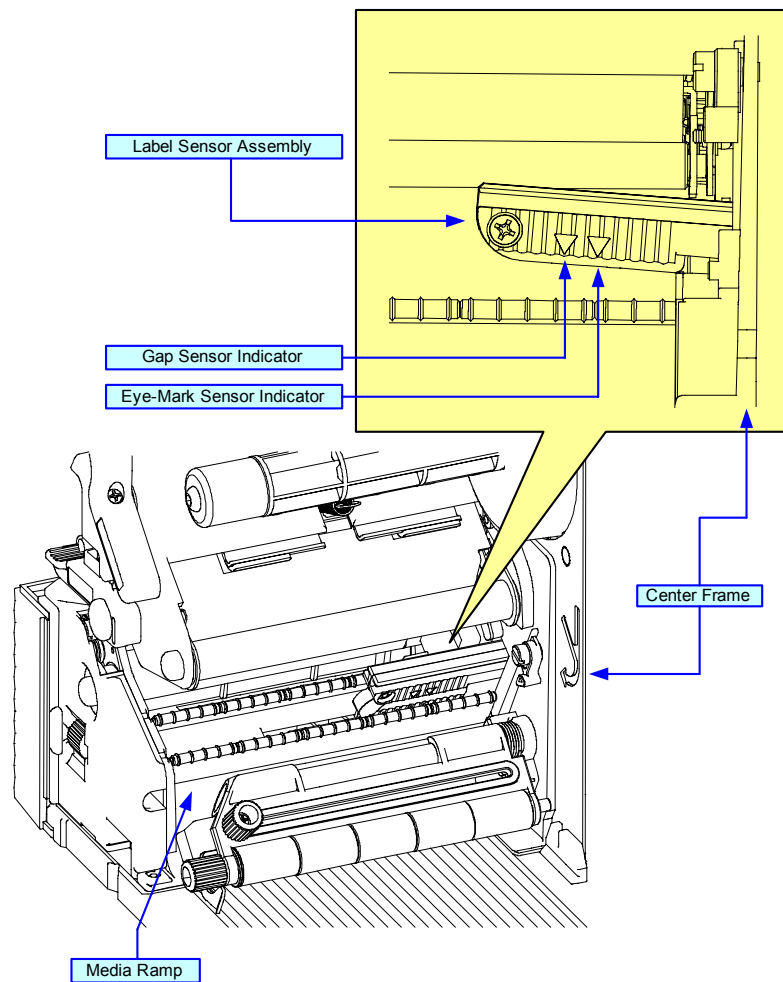

Figure 6-7, Label Sensor Positioning

POTENTIOMETER ADJUSTMENTS

These operational adjustments are for fine tuning the printer as necessary following the configuration process and are largely confined to the four potentiometers located on the operator panel. Refer to the table below for their function.

POTENTIOMETER	DESCRIPTION/PROCEDURE
VOLUME	Adjusts the audible decimal level for error indication. Power on the printer, place on-line, and open the print head. When the beep is emitted, adjust the volume level accordingly.
PITCH	<p>Is to be used in conjunction with the configuration adjustments. Make course adjustments there and then fine tune here. If unable to achieve the desired setting here, the course adjustment must be reset. Adjust this potentiometer as labels are being printed. Allow two labels to be printed for each adjustment to ensure a desired setting.</p> <p>Adjustment of the PITCH potentiometer will affect the print offset position. Thusly, if using a dispenser or cutter, adjust the Offset first and then the Pitch.</p>
OFFSET	<p>The offset adjustment is used to reposition the media for printing following advancement for dispensing or cutting. A label is printed, it is fed forward for dispense, the printer retracts the remaining media (offset) to print the next label. To preform this adjustment:</p> <ol style="list-style-type: none"> 1. Power On the printer. 2. Press the LINE key to place printer offline. 3. Advance to the User Mode and press ENTER. 4. Adjust the OFFSET potentiometer. 5. Press the FEED key to feed another label. 6. Repeat steps 3 and 4 until properly adjusted. 7. Press the LINE key to bring the printer back online.
DARKNESS	<p>Is used to adjust the darkness or lightness of the printed image and should be used in conjunction with the configuration adjustments. Make course adjustments there and then fine tune here. If unable to achieve the desired setting here, the course adjustment must be reset.</p> <p>Adjust this potentiometer as labels are being printed. Allow two labels to be printed for each adjustment to ensure a desired setting.</p>

