



Parts List

For printer model:

CG408 / CG412

PN: 9001220B



SATO America
10350-A Nations Ford Road
Charlotte, NC 28273

Main Phone: (704) 644-1650
Technical Support: (704) 644-1660
Technical Support Fax: (704) 644-1661
E-Mail: sales-sallic@sato-global.com

www.satoamerica.com

© SATO America, 2016
All rights reserved.

No	Part No.	Description
9	MH0300822	PAN HEAD P TIGHT SCREW
10	M16249000	BIND HEAD P TIGHT SCREW
11	MH9300822	P TIGHT SCREW
12	P27066000	GUIDE STOPPER
13	P27067000	SPRING (G.STOPPER)
43	R16570010	BOTTOM FRAME SA
44	P32670011	LABEL GUIDE L
45	P32671011	GUIDE COVER L
46	P32672002	SENSOR COVER
47	P32673012	LABEL GUIDE R
48	P32674000	SHAFT (LABEL GUIDE)
71	PJ0A20500	GEAR (LABEL GUIDE)
78	Q02578000	STICKER (LABEL ROUTE)
81	Q02589000	STICKER (CAUTION)
86	R13004000	IM&GAP PCB SET-LF
87	R13005000	GAP PCB SET-LF
91	R14265010	SENSOR CABLE SET (DT)-LF
101	R15050010	SENSOR CABLE SET (TT)-LF
110	R14466020	BOTTOM FRAME SET
111	R16522001	SENSOR COVER SET

Fig PL1a, Bottom Assembly

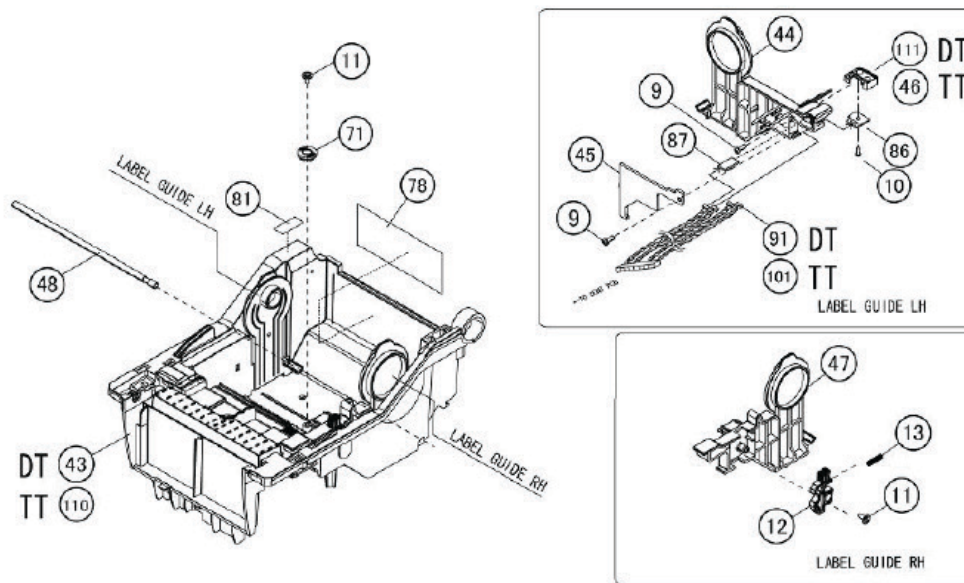

No	Part No.	Description
6	K00292000	STEPPING MOTOR
8	MD4300822	PAN HEAD SCREW
14	P27072000	SPACER
15	P27073000	DOUBLE GEAR (Z45*Z30)
16	P27074000	GEAR (Z40)
49	P32675000	MOTOR BRACKET
50	P32676011	GEAR BOX

Fig PL1b, Bottom Assembly

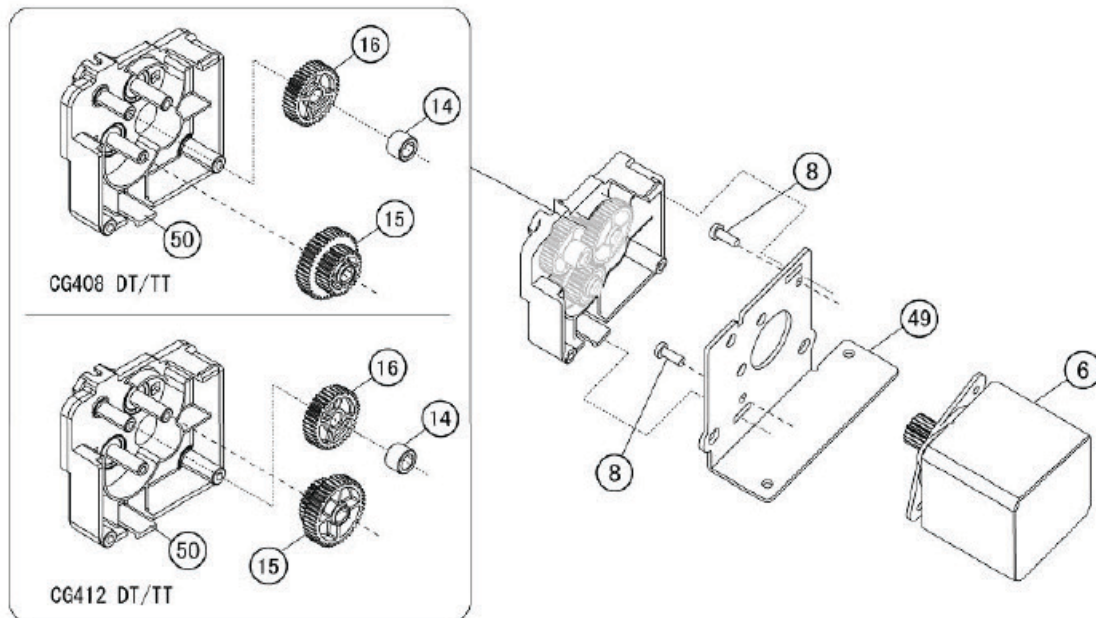

No	Part No.	Description
9	MH0300822	PAN HEAD P TIGHT SCREW
88	R16252000	COVER SENSOR PCB
112	H02056000	CABLE CLAMP

Fig PL1c, Bottom Assembly

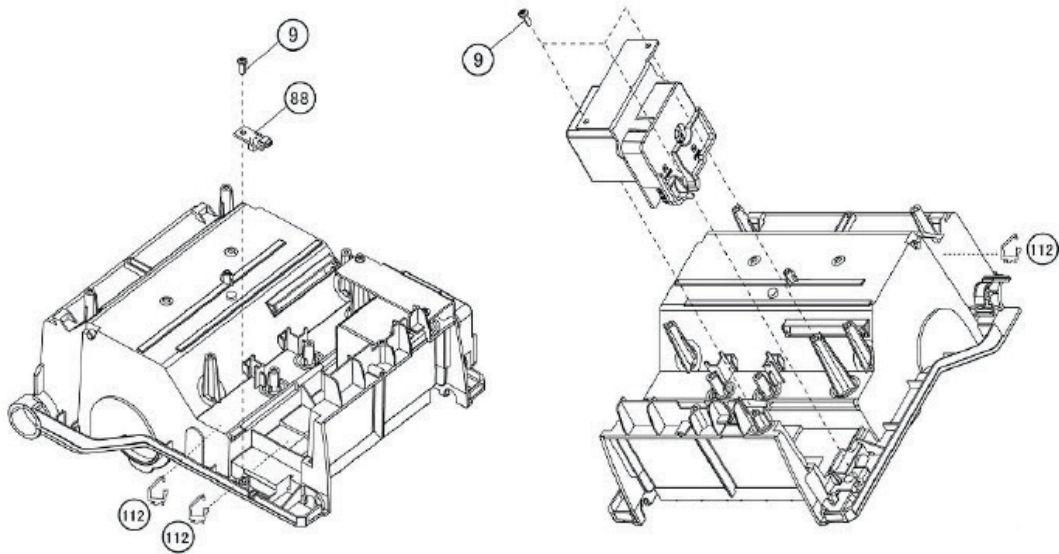

No	Part No.	Description
9	MH0300822	PAN HEAD P TIGHT SCREW
28	P31363000	WASHER
52	P32680011	REAR I/F PANEL (RS232C)
53	P32680111	REAR I/F PANEL (LAN)
54	P32680211	REAR I/F PANEL (IEEE1284)
55	P32683011	BOTTOM COVER
56	P32684000	RUBBER FOOT
57	P32685011	FRONT PANEL (STD)
95	R14471010	PLATEN ROLLER SAB CG4XTT/DT
97	R14481011	PRINT HEAD (8 DPMM) CG408DT
98	R14482011	PRINT HEAD (12 DPMM) CG412DT
102	R15396002	MAIN PCB (RS232C) CG4XTT/DT
103	R15397002	MAIN PCB (IEEE1284) CG4XTT/DT
104	R15398002	MAIN PCB (LAN) CG4XTT/DT
116	MH2301022	BIND HEAD P TIGHT SCREW

Fig PL1d, Bottom Assembly

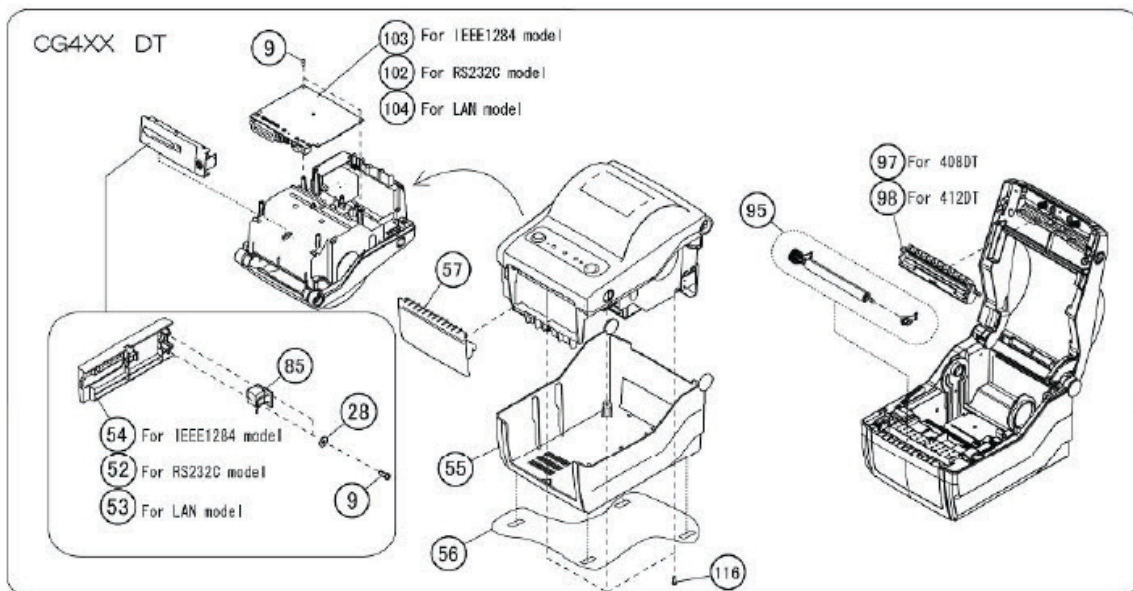

No	Part No.	Description
9	MH0300822	PAN HEAD P TIGHT SCREW
28	P31363000	WASHER
42	P32666011	R ADJUST PLATE
52	P32680011	REAR I/F PANEL (RS232C)
53	P32680111	REAR I/F PANEL (LAN)
54	P32680211	REAR I/F PANEL (IEEE1284)
55	P32683011	BOTTOM COVER
56	P32684000	RUBBER FOOT
57	P32685011	FRONT PANEL (STD)
65	P32697010	SPRING (HEAD)
67	P32825002	WINDOW (TT)
93	R14464020	PRINT HEAD (8 DPMM) CG408TT
94	R14465020	PRINT HEAD (12DPMM) CG412TT
95	R14471010	PLATEN ROLLER SAB CG4XXTT/DT
102	R15396002	MAIN PCB (RS232C) CG4XXTT/DT
103	R15397002	MAIN PCB (IEEE1284) CG4XXTT/DT
104	R15398002	MAIN PCB (LAN) CG4XXTT/DT
116	MH2301022	BIND HEAD P TIGHT SCREW

Fig PL1e, Bottom Assembly

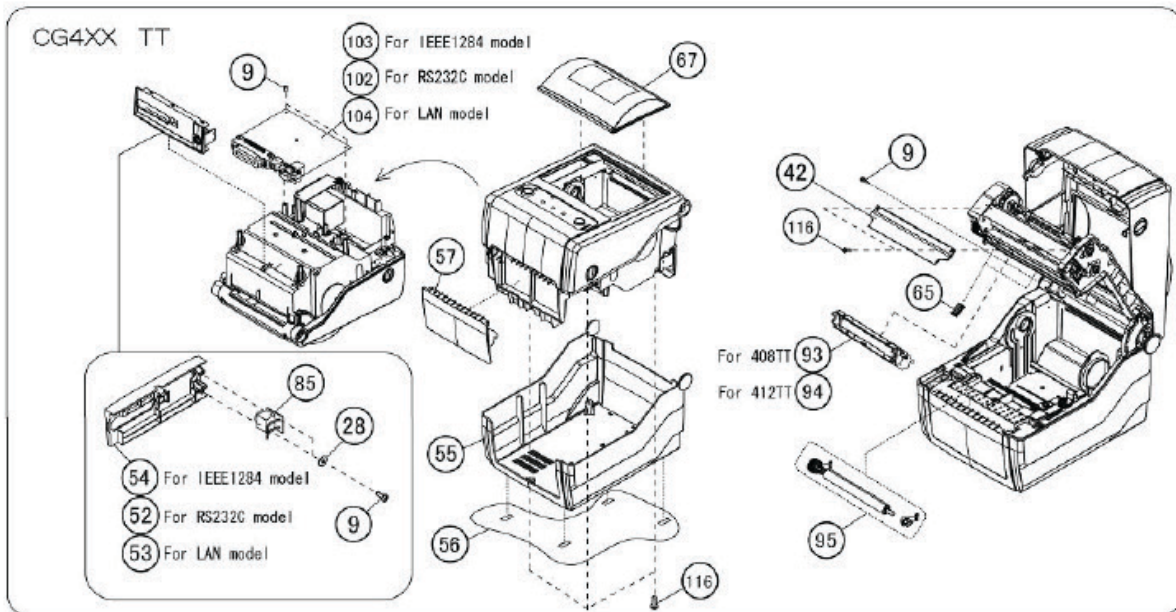

No	Part No.	Description
9	MH0300822	PAN HEAD P TIGHT SCREW
58	P32686020	TOP COVER (DT)
59	P32688011	BUTTON (DT)
61	P32693001	SPRING (OPEN LEVER)
79	Q02579000	OPERATION SHEET
84	R12991000	KB PCB SET-LF
90	R14263010	KB CABLE SET (DT)-LF
96	R14480021	OPEN LEVER SET (DT)

Fig PL2a, Top Cover Assembly

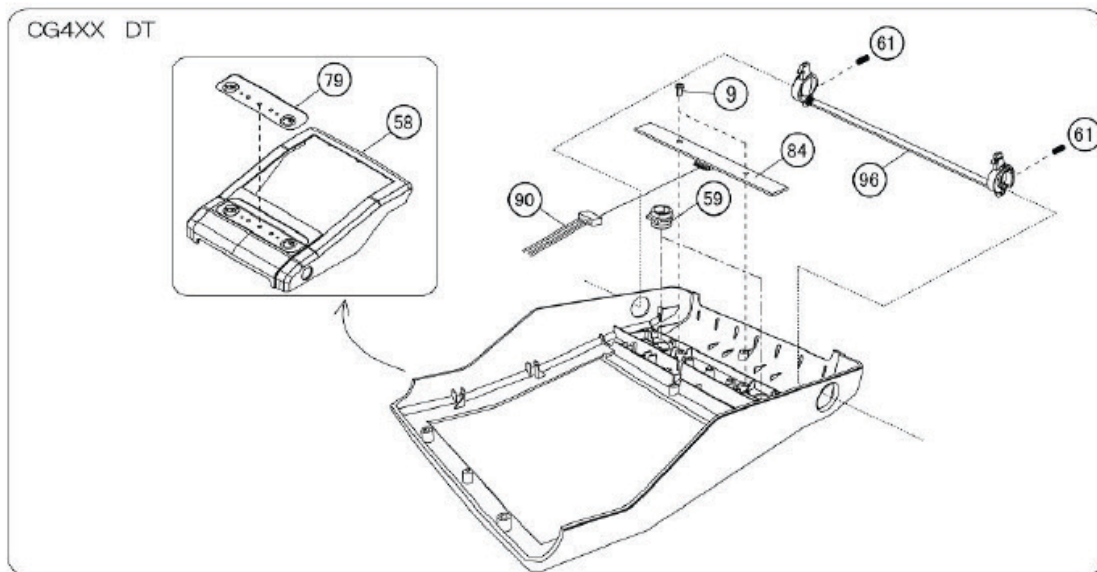

No	Part No.	Description
9	MH0300822	PAN HEAD P TIGHT SCREW
29	P32644021	TOP COVER (TT)
30	P32648001	TOP COVER HINGE
31	P32649011	BUTTON (TT)
61	P32693001	SPRING (OPEN LEVER)
79	Q02579000	OPERATION SHEET
84	R12991000	KB PCB SET-LF
92	R14461012	OPEN LEVER SET (TT)
100	R15048000	KB CABLE SET (TT)-LF

Fig PL2b, Top Cover Assembly

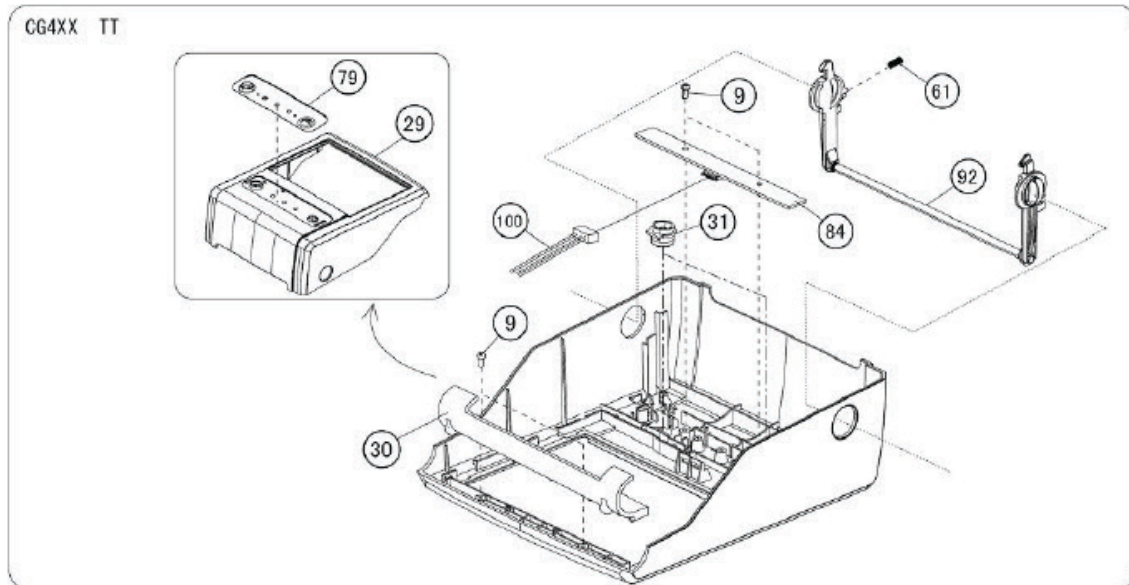

No	Part No.	Description
9	MH0300822	PAN HEAD P TIGHT SCREW
51	P32678011	BOTTOM FRAME HINGE
60	P32690001	WINDOW (DT)
62	P32694020	TOP FRAME
63	P32695011	SWING STOPPER (DT)
64	P32696010	HEAD RELEASE LEVER (DT)
65	P32697010	SPRING (HEAD)
74	Q02348000	STICKER (HEAT CAUTION)
83	R12875010	HEAD CABLE SET (DT)-LF
113	J00056000	SPIRAL TUBE (25)

Fig PL2c, Top Cover Assembly

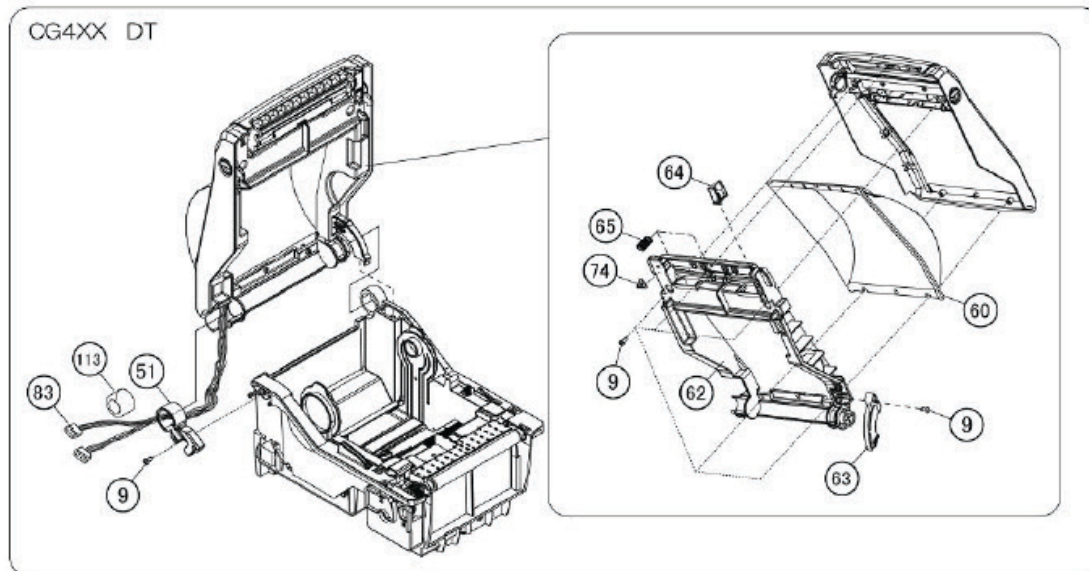

No	Part No.	Description
3	JG100011A	TIE WRAP
9	MH0300822	PAN HEAD P TIGHT SCREW
11	MH9300822	P TIGHT SCREW
17	P27101010	CORE GUIDE
18	P27105010	TQ.LIMITER PLATE A (R)
19	P27106000	TQ.LIMITER PLATE B (R)
20	P27108000	TQ.LIMITER PLATE A (U)
21	P27109000	TQ.LIMITER PLATE B (U)
22	P27111010	TORSION SPRING
23	P27112000	FELT PLATE
24	P27113000	ENCODER
25	P30662000	TQ.LIMITER WASHER
26	P30663000	SHAFT (ENCODER)
27	P31066000	CLUTCH-GEAR
28	P31363000	WASHER (d3.3*D9*t0.8)
32	P32652080	RIBBON FRAME

Fig PL3a, Ribbon Frame Assembly

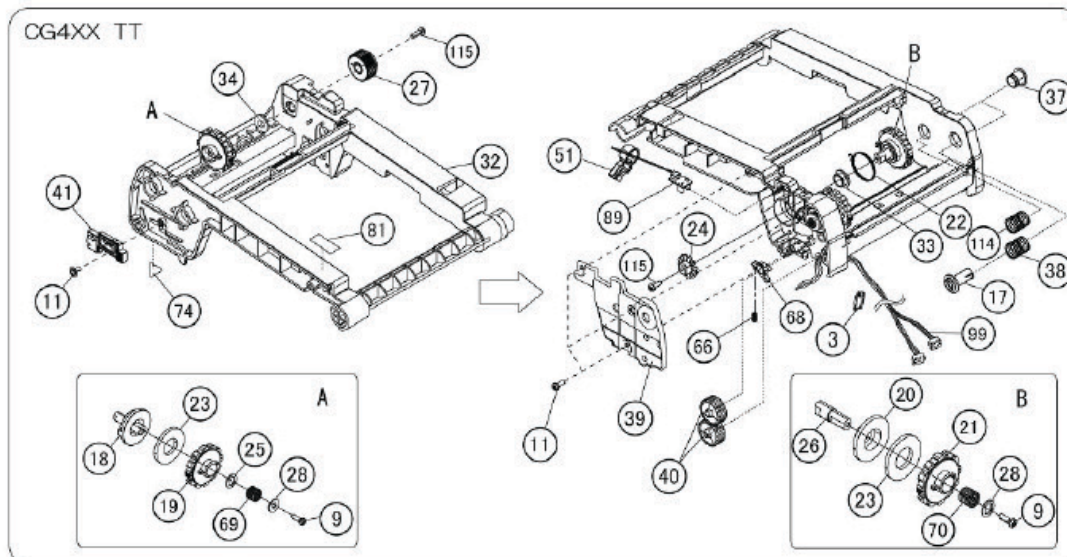

No	Part No.	Description
33	P32653010	RIBBON BUSH (U)
34	P32654010	RIBBON BUSH (R)
37	P32659010	CORE GUIDE BUSH
38	P36056000	SPRING (CORE GUIDE)
39	P32662011	GEAR COVER
40	P32663000	GEAR (IDLE)
41	P32664020	HEAD RELEASE LEVER (TT)
51	P32678011	BOTTOM FRAME HINGE
66	P32814000	SPRING (GEAR STOPPER)
68	P32829010	GEAR STOPPER
69	P32888000	TQ.SPRING (R)
70	P33423010	TQ.SPRING (U)
74	Q02348000	STICKER (HEAT CAUTION)
81	Q02589000	STICKER (CAUTION)
89	R16253000	RIBBON SENSOR PCB SET-LF
99	R15041000	HEAD CABLE SET (TT)-LF
114	P36625000	SPRING (CORE GUIDE U)
115	MH0301221	P TITE SCREW

Fig PL3a, Ribbon Frame Assembly

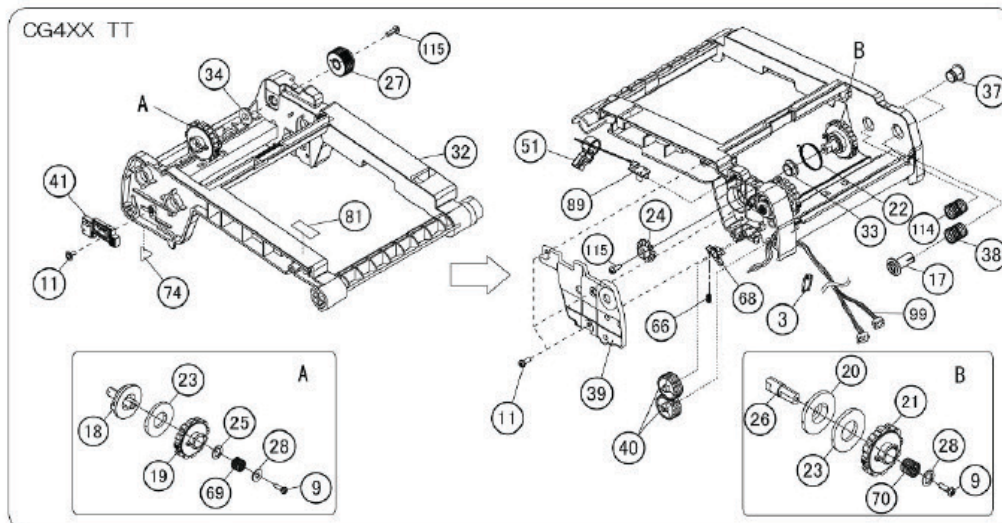

No	Part No.	Description
9	MH0300822	PAN HEAD P TIGHT SCREW
35	P32656011	SWING STOPPER (TT)
36	P32657012	RIBBON COVER
80	Q02580000	STICKER (RIBBON ROUTE)

Fig PL3b, Ribbon Frame Assembly

CG4XX TT

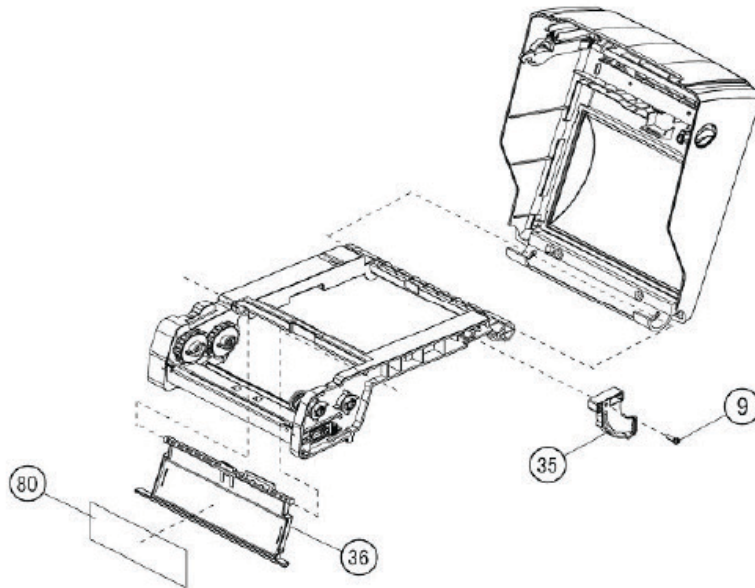

No	Part No.	Description
4	JH000451A	AC POWER CORD ASSEMBLY 220V
5	JH000441A	AC CABLE (1-) 100V
7	K00294010	AC ADAPTOR-LF

Fig PL5, Attachment Assembly

